

## Contents

<b>1 Safety</b>	<b>5</b>
Safety instructions	5
Software Version and Approvals	6
General Warning	7
Avoid unintended Start	7
Before Commencing Repair Work	8
<b>2 Mechanical Installation</b>	<b>9</b>
Before Starting	9
Mechanical Dimensions	10
<b>3 Electrical Installation</b>	<b>11</b>
How to Connect	11
Electrical Installation in General	11
EMC-Correct Installation	12
Mains Connection	12
Motor Connection	13
Control Terminals	14
Connecting to Control Terminals	15
Switches	15
Power Circuit - Overview	15
Load sharing/Brake	16
<b>4 Programming</b>	<b>17</b>
How to Programme	17
Programming with MCT-10 Set-up Software	17
Programming with the LCP 11 or LCP 12	17
Status Menu	19
Quick Menu	19
Quick Menu Parameters	20
Main Menu	24
<b>5 Modbus RTU</b>	<b>25</b>
Modbus RTU Overview	25
Modbus RTU Message Framing Structure	26
Remote Terminal Unit	26
Modbus RTU Message Structure	26
Start/Stop Field	26
Address Field	27
Function Field	27
Data Field	27

CRC Check Field	27
Coil/Register Addressing	27
How to Control the frequency converter	29
Function Codes Supported by Modbus RTU	29
Exception and Error Codes	29
How to Access Parameters	30
Parameter Handling	30
Storage of Data	30
IND	30
Text Blocks	30
Conversion Factor	30
Parameter Values	30
Examples	30
Read Coil Status (01 <sub>HEX</sub> )	31
Force/Write Single Coil (05 <sub>HEX</sub> )	31
Force/Write Multiple Coils (0F <sub>HEX</sub> )	32
Read Holding Registers (03 <sub>HEX</sub> )	32
Preset Single Register (06 <sub>HEX</sub> )	33
Preset Multiple Registers (10 <sub>HEX</sub> )	34
Danfoss FC Control Profile	35
Control Word According to FC Profile	35
Explanation of the Control Bits	35
Status Word According to FC Profile (STW)	37
Explanation of the Status Bits	38
Bus Speed Reference Value	39
<b>6 Parameter Overview</b>	<b>41</b>
Conversion Index	45
Change during operation	45
2-Set-up	45
Type	45
0-** Operation/Display	46
1-** Load/Motor	47
2-** Brakes	48
3-** Reference/Ramps	49
4-** Limits/Warnings	50
5-** Digital In/Out	51
6-** Analog In/Out	52
7-** Controllers	53
8-** Comm. and Options	54
13-** Smart Logic	55

14-** Special Functions	56
15-** Drive Information	57
16-** Data Readouts	58
<b>7 Troubleshooting</b>	<b>59</b>
Alarm, Warning and Extended Status Word	60
<b>8 Specifications</b>	<b>61</b>
Mains Supply	61
Other Specifications	63
Special Conditions	65
The Purpose of Derating	65
Derating for Ambient Temperature	65
Derating for Low Air Pressure	65
Derating for Running at Low Speeds	65
Options for VLT Micro Drive FC 51	66
<b>Index</b>	<b>67</b>

1

# 1 Safety

# 1

## 1.1.1 High Voltage Warning



The voltage of the frequency converter is dangerous whenever it is connected to mains. Incorrect installation of the motor or frequency converter may cause damage to the equipment, serious injury or death. Consequently, it is essential to comply with the instructions in this manual as well as local and national rules and safety regulations.

## 1.1.2 Safety instructions



Prior to using functions directly or indirectly influencing personal safety (e.g. **Safe Stop**, **Fire Mode** or other functions either forcing the motor to stop or attempting to keep it functioning) a thorough **risk analysis** and **system test** must be carried through. The system tests **must** include testing failure modes regarding the control signalling (analog and digital signals and serial communication).



**NB!**  
Before using **Fire Mode**, contact **Danfoss**

- Make sure the frequency converter is properly connected to earth.
- Do not remove mains connections, motor connections or other power connections while the frequency converter is connected to power.
- Protect users against supply voltage.
- Protect the motor against overloading according to national and local regulations.
- The earth leakage current exceeds 3.5 mA.
- The [OFF] key is not a safety switch. It does not disconnect the frequency converter from mains.

## 1.1.3 Software Version and Approvals

1

# Software Version Operating Instructions VLT Micro Drive FC 51 Series



This Operating Instructions can be used for all VLT Micro Drive FC 51 frequency converters with software version 2.2x.

The software version number can be read in parameter 15-43.

### 1.1.4 General Warning



**Warning:**  
 Touching the electrical parts may be fatal - even after the equipment has been disconnected from mains.  
 Also make sure that other voltage inputs have been disconnected (linkage of DC intermediate circuit).  
 Be aware that there may be high voltage on the DC link even when the LEDs are turned off.  
 Before touching any potentially live parts of the frequency converter, wait at least 4 minutes for all sizes.  
 Shorter time is allowed only if indicated on the nameplate for the specific unit.



**Leakage Current**  
 The earth leakage current from the frequency converter exceeds 3.5 mA. According to IEC 61800-5-1 a reinforced Protective Earth connection must be ensured by means of a min. 10mm<sup>2</sup> Cu or an additional PE wire - with the same cable cross section as the Mains wiring - must be terminated separately.

**Residual Current Device**  
 This product can cause a DC current in the protective conductor. Where a residual current device (RCD) is used for extra protection, only an RCD of Type B (time delayed) shall be used on the supply side of this product. See also Danfoss Application Note on RCD, MN. 90.GX.YY.  
 Protective earthing of the frequency converter and the use of RCDs must always follow national and local regulations.



Motor overload protection is possible by setting Parameter 1-90 Motor thermal protection to the value ETR trip. For the North American market: ETR functions provide class 20 motor overload protection, in accordance with NEC.



**Installation in high altitudes:**  
 For altitudes above 2 km, please contact Danfoss regarding PELV.

### 1.1.5 IT Mains



**IT Mains**  
 Installation on isolated mains source, i.e. IT mains.  
 Max. supply voltage allowed when connected to mains: 440 V.

As an option, Danfoss offers line filters for improved harmonics performance.

### 1.1.6 Avoid unintended Start

While the frequency converter is connected to mains, the motor can be started/stopped using digital commands, bus commands, references or via the Local Control Panel.

- Disconnect the frequency converter from mains whenever personal safety considerations make it necessary to avoid unintended start of any motors.
- To avoid unintended start, always activate the [OFF] key before changing parameters.

**1**

### 1.1.7 Disposal instruction



Equipment containing electrical components must not be disposed of together with domestic waste. It must be separately collected with electrical and electronic waste according to local and currently valid legislation.

### 1.1.8 Before Commencing Repair Work

1. Disconnect FC 51 from mains (and external DC supply, if present.)
2. Wait for 4 minutes for discharge of the DC-link.
3. Disconnect DC bus terminals and brake terminals (if present)
4. Remove motor cable



## 2 Mechanical Installation

### 2.1 Before Starting

#### 2.1.1 Checklist

When unpacking the frequency converter, make sure that the unit is undamaged and complete. Check that the packaging contains the following:

- VLT Micro Drive FC 51
- Quick Guide

Optional: LCP and/or de-coupling plate.

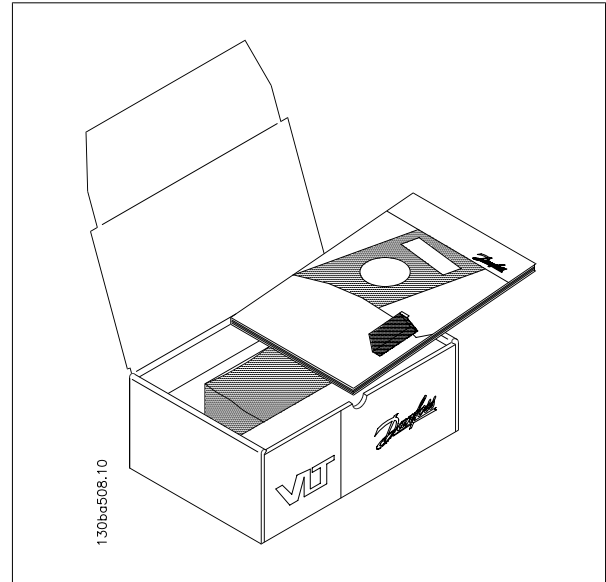

Illustration 2.1: Content of box.

### 2.2 Side-by-Side Installation

The frequency converter can be mounted side-by-side for IP 20 rating units and requires 100 mm clearance above and below for cooling. Regarding surroundings in general, please see chapter 7. *Specifications*.

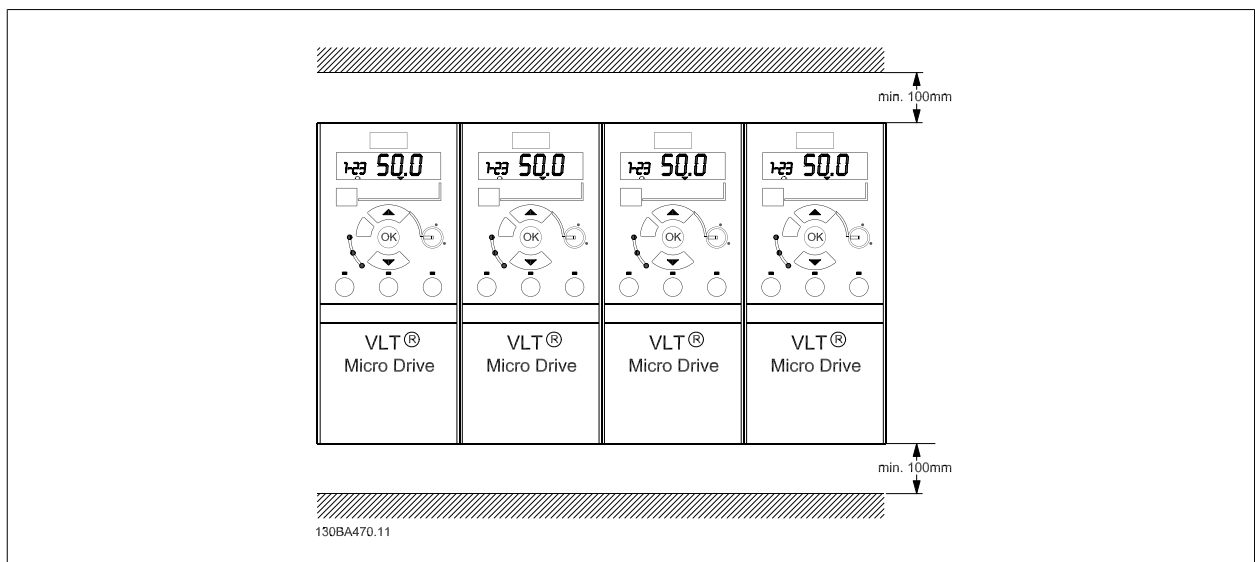

Illustration 2.1: Side-by-side installation.

2

2.3.1 Mechanical Dimensions

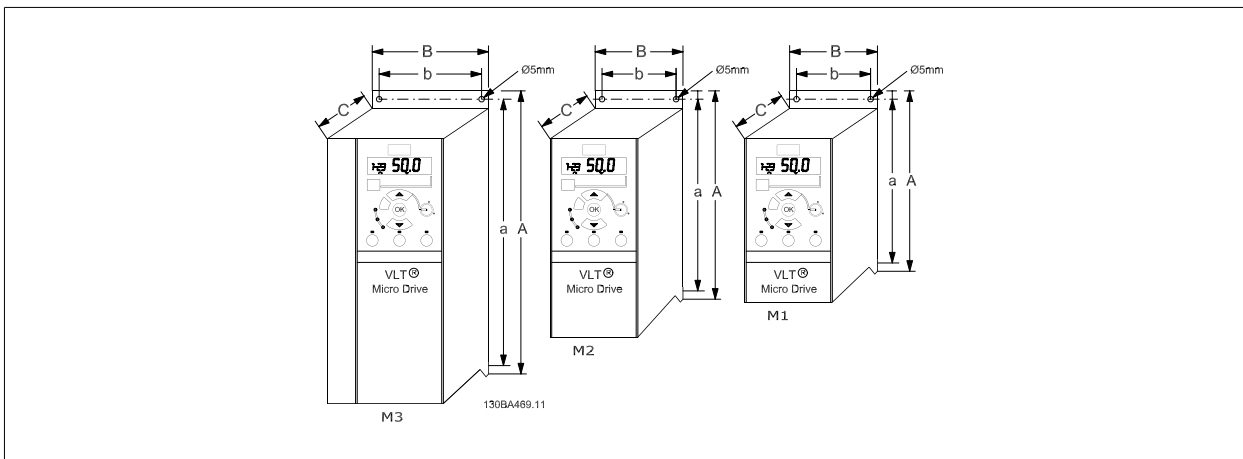

Illustration 2.1: Mechanical dimensions.

**NB!**  
 A template for drilling can be found on the flap of the packaging.

Frame	Power (kW)			Height (mm)			Width (mm)		Depth <sup>1)</sup> (mm)	Max. Weight
	1 X 200-240 V	3 X 200 -240 V	3 X 380-480 V	A	A (incl. decoupling plate)	a	B	b	C	Kg
M1	0.18 - 0.75	0.25 - 0.75	0.37 - 0.75	150	205	140.4	70	55	148	1.1
M2	1.5	1.5	1.5 - 2.2	176	230	166.4	75	59	168	1.6
M3	2.2	2.2 -3.7	3.0 - 7.5	239	294	226	90	69	194	3.0

Table 2.1: Mechanical Dimensions

<sup>1)</sup> For LCP with potentiometer, please add 7.6 mm.

**NB!**  
 DIN rail mounting kit is available for M1 frame . Please use ordering number 132B0111.

## 3 Electrical Installation

### 3.1 How to Connect

#### 3.1.1 Electrical Installation in General



**NB!**

All cabling must comply with national and local regulations on cable cross-sections and ambient temperature. Copper conductors required, (60-75° C) recommended.

**3**

**Details of terminal tightening torques.**

Frame	Power (kW)			Torque (Nm)					
	1 x 200-240 V	3 x 200-240 V	3 x 380-480 V	Line	Motor	DC connection/Brake <sup>1)</sup>	Control Terminals	Earth	Relay
M1	0.18 - 0.75	0.25 - 0.75	0.37 - 0.75	1.4	0.7	-	0.15	3	0.5
M2	1.5	1.5	1.5 - 2.2	1.4	0.7	-	0.15	3	0.5
M3	2.2	2.2 - 3.7	3.0 - 7.5	1.4	0.7	-	0.15	3	0.5

<sup>1)</sup> Spade connectors (6.3 mm Faston plugs)

Table 3.1: Tightening of terminals.

#### 3.1.2 Fuses

**Branch circuit protection:**

In order to protect the installation against electrical and fire hazard, all branch circuits in an installation, switch gear, machines etc., must be short-circuited and overcurrent protected according to national/international regulations.

**Short circuit protection:**

Danfoss recommends using the fuses mentioned in the following tables to protect service personnel or other equipment in case of an internal failure in the unit or short-circuit on DC-link. The frequency converter provides full short circuit protection in case of a short-circuit on the motor or brake output. a circuit capable of supplying a maximum of 100,000 A<sub>rms</sub> (symmetrical), 480 V maximum.

**Overcurrent protection:**

Provide overload protection to avoid overheating of the cables in the installation. Overcurrent protection must always be carried out according to national regulations. Fuses must be designed for protection in a circuit capable of supplying a maximum of 100,000 A<sub>rms</sub> (symmetrical), 480 V maximum.

**Non UL compliance:**

If UL/cUL is not to be complied with, Danfoss recommends using the fuses mentioned in the below table, which will ensure compliance with EN50178/IEC61800-5-1:

In case of malfunction, not following the fuse recommendation may result in damage to the frequency converter.

FC 51	UL						Max. fuses non UL
	Bussmann	Bussmann	Bussmann	Littel fuse	Ferraz-Shawmut	Ferraz-Shawmut	
<b>1 X 200-240 V</b>							
kW	Type RK1	Type J	Type T	Type RK1	Type CC	Type RK1	Type gG
0K18 - 0K37	KTN-R15	JKS-15	JJN-15	KLN-R15	ATM-R15	A2K-15R	15A
0K75	KTN-R25	JKS-25	JJN-25	KLN-R25	ATM-R25	A2K-25R	25A
1K5	KTN-R35	JKS-35	JJN-35	KLN-R35	-	A2K-35R	35A
2K2	KTN-R45	JKS-45	JJN-45	KLN-R45	-	A2K-45R	45A
<b>3 x 200-240 V</b>							
0K25	KTN-R10	JKS-10	JJN-10	KLN-R10	ATM-R10	A2K-10R	10A
0K37	KTN-R15	JKS-15	JJN-15	KLN-R15	ATM-R15	A2K-15R	15A
0K75	KTN-R20	JKS-20	JJN-20	KLN-R20	ATM-R20	A2K-20R	20A
1K5	KTN-R25	JKS-25	JJN-25	KLN-R25	ATM-R25	A2K-25R	25A
2K2	KTN-R40	JKS-40	JJN-40	KLN-R40	ATM-R40	A2K-40R	40A
3K7	KTN-R40	JKS-40	JJN-40	KLN-R40	-	A2K-40R	40A
<b>3 x 380-480 V</b>							
0K37 - 0K75	KTS-R10	JKS-10	JJS-10	KLS-R10	ATM-R10	A6K-10R	10A
1K5	KTS-R15	JKS-15	JJS-15	KLS-R15	ATM-R15	A2K-15R	15A
2K2	KTS-R20	JKS-20	JJS-20	KLS-R20	ATM-R20	A6K-20R	20A
3K0	KTS-R40	JKS-40	JJS-40	KLS-R40	ATM-R40	A6K405R	40A
4K0	KTS-R40	JKS-40	JJS-40	KLS-R40	ATM-R40	A6K-40R	40A
5K5	KTS-R40	JKS-40	JJS-40	KLS-R40	-	A6K-40R	40A
7K5	KTS-R40	JKS-40	JJS-40	KLS-R40	-	A6K-40R	40A

Table 3.3: Fuses

### 3.1.3 EMC-Correct Installation

Following these guidelines is advised, where compliance with EN 61000-6-3/4, EN 55011 or EN 61800-3 *First environment* is required. If the installation is in EN 61800-3 *Second environment*, then it is acceptable to deviate from these guidelines. It is however not recommended.

#### Good engineering practice to ensure EMC-correct electrical installation:

- Use only braided screened/armoured motor cables and control cables.  
The screen should provide a minimum coverage of 80%. The screen material must be metal, not limited to but typically copper, aluminium, steel or lead. There are no special requirements for the mains cable.
- Installations using rigid metal conduits are not required to use screened cable, but the motor cable must be installed in conduit separate from the control and mains cables. Full connection of the conduit from the drive to the motor is required. The EMC performance of flexible conduits varies a lot and information from the manufacturer must be obtained.
- Connect the screen/armour/conduit to earth at both ends for motor cables and control cables.
- Avoid terminating the screen/armour with twisted ends (pigtailed). Such a termination increases the high frequency impedance of the screen, which reduces its effectiveness at high frequencies. Use low impedance cable clamps or glands instead.
- Ensure good electrical contact between the de-coupling plate and the metal chassis of the frequency converter, see Instruction MI.02.BX.YY.
- Avoid using unscreened/unarmoured motor or control cables inside cabinets housing the drive(s), where possible.

## 3.2 Mains Connection

### 3.2.1 Connecting to Mains

Step 1: First mount earth cable.

Step 2: Mount wires in terminals L1/L, L2 and L3/N and tighten.

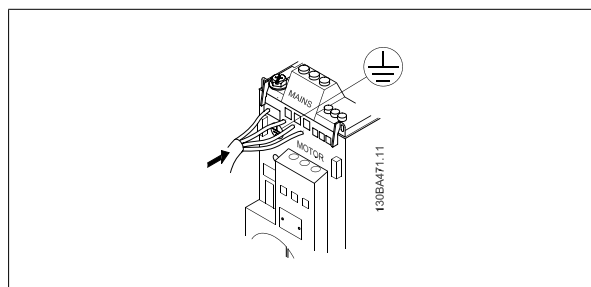

Illustration 3.1: Mounting of earth cable and mains wires.

For 3-phase connection, connect wires to all three terminals.  
 For single-phase connection, connect wires to terminals L1/L and L3/N.

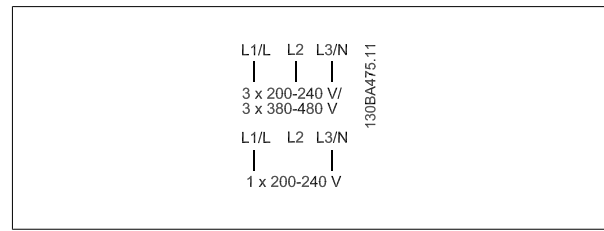

Illustration 3.2: Three-phase and single-phase wire connections.

### 3.3 Motor Connection

#### 3.3.1 How to Connect the Motor

See the chapter *Specifications* for correct dimensioning of motor cable cross-section and length.

- Use a shielded/armored motor cable to comply with EMC emission specifications, and connect this cable to both the decoupling plate and the motor metal.
- Keep motor cable as short as possible to reduce the noise level and leakage currents.

For further details on mounting of the decoupling plate, please see instruction MI.02.BX.YY.

All types of three-phased asynchronous standard motors can be connected to the frequency converter. Normally, small motors are star-connected (230/400 V, Δ/Y). Large motors are delta-connected (400/690 V, Δ/Y). Refer to motor nameplate for correct connection and voltage.

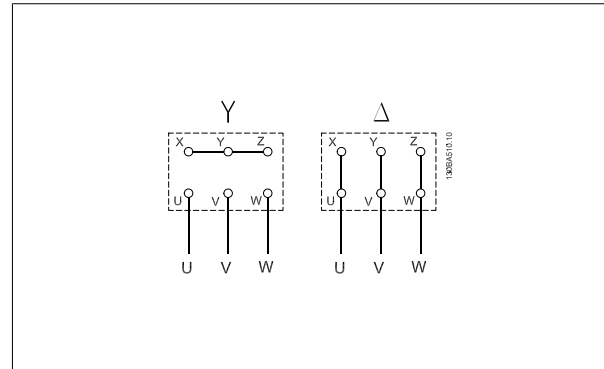

Illustration 3.3: Star and delta connections.

Step 1: First, mount the earth cable.

Step 2: Connect wires to terminals either in star or delta-connection. See motor nameplate for further information.

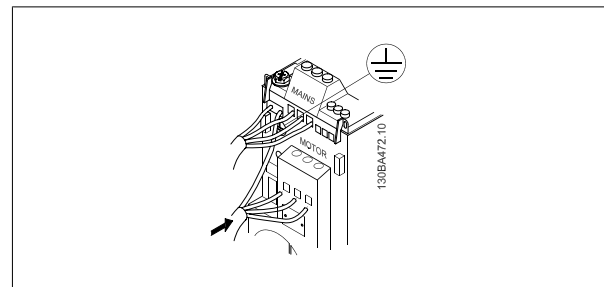

Illustration 3.4: Mounting of earth cable and motor wires.

For EMC correct installation, use optional de-coupling plate, see chapter *Options for frequency converter*.

3

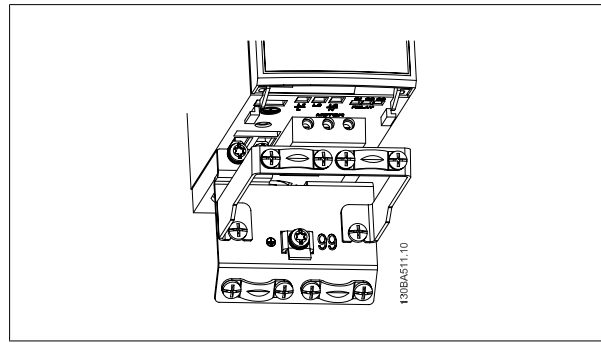

Illustration 3.5: Frequency converter with de-coupling plate

## 3.4 Control Terminals

### 3.4.1 Access to Control Terminals

All control cable terminals are located underneath the terminal cover in front of the frequency converter. Remove the terminal cover using a screwdriver.

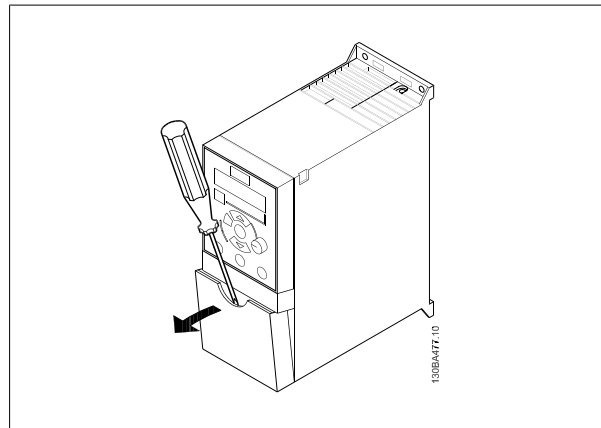

Illustration 3.6: Removing terminal cover.



**NB!**

See back of terminal cover for outlines of control terminals and switches.

### 3.4.2 Connecting to Control Terminals

This illustration shows all control terminals of the frequency converter. Applying Start (term. 18) and an analog reference (term. 53 or 60) make the frequency converter run.

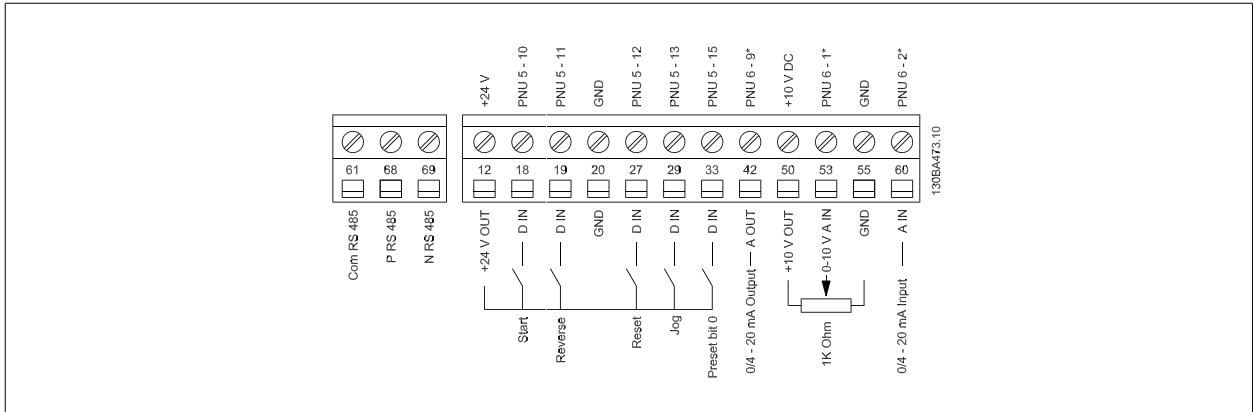

Illustration 3.7: Overview of control terminals in PNP-configuration and factory setting.

### 3.5 Switches

**NB!**  
Do not operate switches with power on the frequency converter.

**Bus termination:**

Switch *BUS TER* pos. ON terminates the RS485 port, terminals 68, 69. See power circuit drawing.

Default setting = Off.

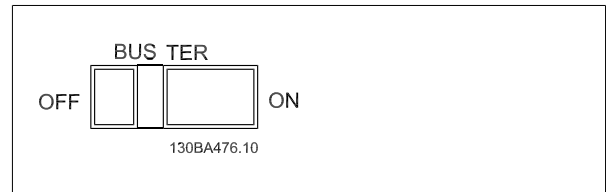

Illustration 3.8: S640 Bus termination.

**S200 Switches 1-4:**

Switch 1:	*OFF = PNP terminals 29 ON = NPN terminals 29
Switch 2:	*OFF = PNP terminal 18, 19, 27 and 33 ON = NPN terminal 18, 19, 27 and 33
Switch 3:	No function
Switch 4:	*OFF = Terminal 53 0 - 10 V ON = Terminal 53 0/4 - 20 mA
* = default setting	

Table 3.5: Settings for S200 Switches 1-4

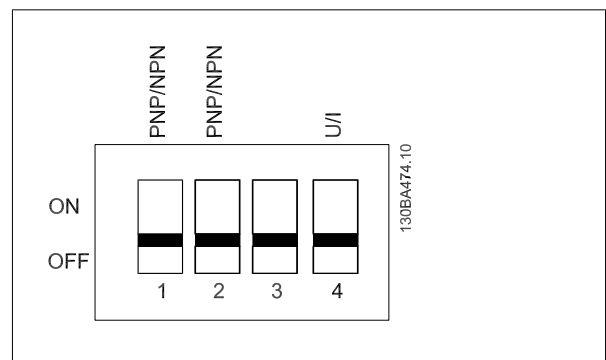

Illustration 3.9: S200 Switches 1-4.

**NB!**  
Parameter 6-19 must be set according to Switch 4 position.

### 3.6 Power Circuit - Overview

#### 3.6.1 Power Circuit - Overview

3

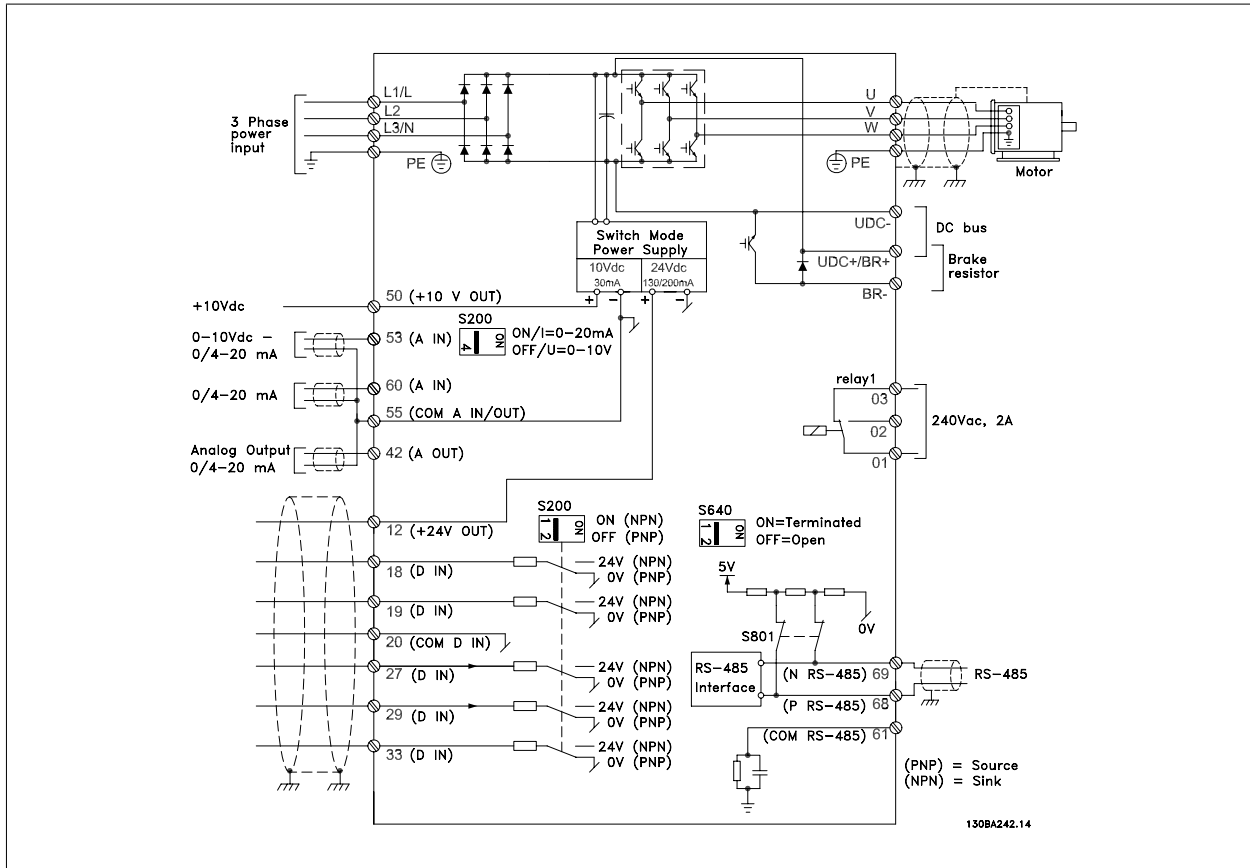

Illustration 3.10: Diagram showing all electrical terminals.

Brake not applicable for frame M1.

Brake resistors are available from Danfoss.

Improved power factor and EMC performance can be achieved by installing optional Danfoss line filters.

Danfoss power filters can also be used for load sharing.

#### 3.6.2 Load sharing/Brake

Use 6.3 mm insulated Faston Plugs designed for high voltage for DC (Load Sharing and brake).

Contact Danfoss or see instruction no. MI.50.Nx.02 for load sharing and instruction no. MI.90.Fx.02 for brake.

Load sharing: Connect terminals UDC- and UDC/BR+.

Brake: Connect terminals BR- and UDC/BR+.



Note that voltage levels of up to 850 V DC may occur between terminals UDC+/BR+ and UDC-. Not short circuit protected.



## 4 Programming

### 4.1 How to Programme

#### 4.1.1 Programming with MCT-10 Set-up Software

The frequency converter can be programmed from a PC via RS485 com-port by installing the MCT-10 Set-up Software.

This software can either be ordered using code number 130B1000 or downloaded from the Danfoss Web site: [www.danfoss.com](http://www.danfoss.com), Business Area: Motion Controls.

Please refer to manual MG.10.RX.YY.

#### 4.1.2 Programming with the LCP 11 or LCP 12

The LCP is divided into four functional groups:

1. Numeric display.
2. Menu key.
3. Navigation keys.
4. Operation keys and indicator lights (LEDs).

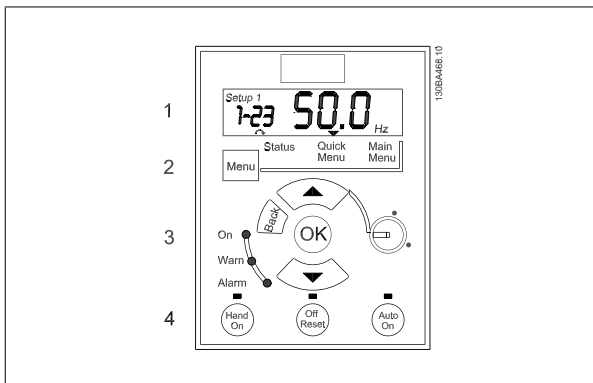

Illustration 4.1: LCP 12 with potentiometer

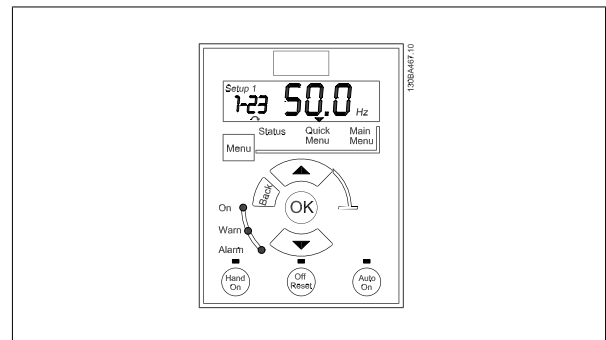

Illustration 4.2: LCP 11 without potentiometer

#### The display:

A number of information can be read from the display.

**Set-up number** shows the active set-up and the edit set-up. If the same set-up acts as both active and edit set-up, only that set-up number is shown (factory setting).

When active and edit set-up differ, both numbers are shown in the display (Setup 12). The number flashing, indicates the edit set-up.

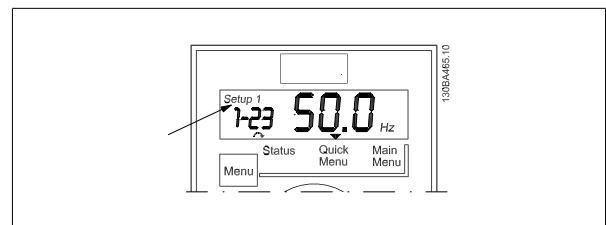

Illustration 4.3: Indicating Set-up

The small digits to the left are the selected **parameter number**.

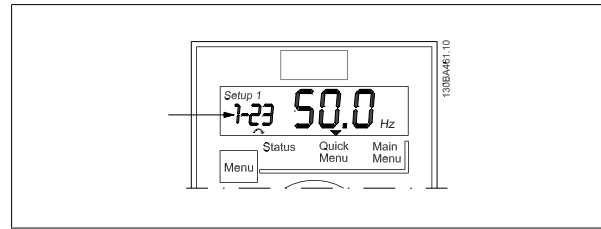

Illustration 4.4: Indicating selected par. no.

The large digits in the middle of the display show the **value** of the selected parameter.

4

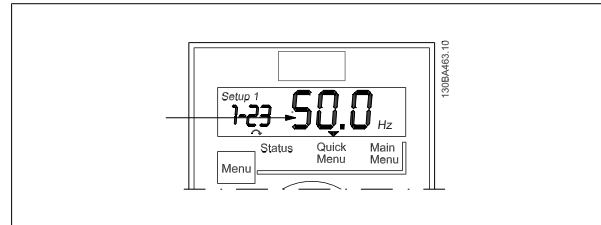

Illustration 4.5: Indicating value of selected par.

The right side of the display shows the **unit** of the selected parameter. This can be either Hz, A, V, kW, HP, %, s or RPM.

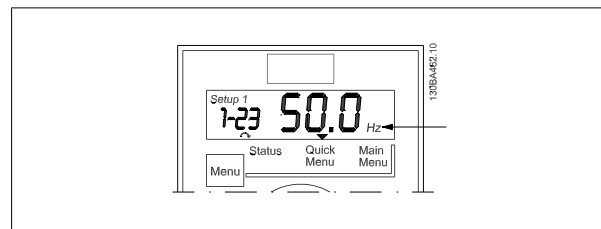

Illustration 4.6: Indicating unit of selected par.

**Motor direction** is shown to the bottom left of the display - indicated by a small arrow pointing either clockwise or counterclockwise.

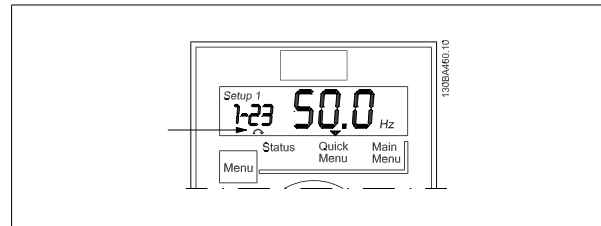

Illustration 4.7: Indicating motor direction

Use the [MENU] key to select one of the following menus:

#### Status Menu:

The Status Menu is either in *Readout Mode* or *Hand on Mode*. In *Readout Mode* the value of the currently selected readout parameter is shown in the display.

In *Hand on Mode* the local LCP reference is displayed.

#### Quick Menu:

Displays Quick Menu parameters and their settings. Parameters in the Quick Menu can be accessed and edited from here. Most applications can be run by setting the parameters in the Quick Menus.

#### Main Menu:

Displays Main Menu parameters and their settings. All parameters can be accessed and edited here. A parameter overview is found later in this manual.

#### Indicator lights:

- Green LED: The frequency converter is on.
- Yellow LED: Indicates a warning. Please see section *Troubleshooting*
- Flashing red LED: Indicates an alarm. Please see section *Troubleshooting*

**Navigation Keys:**

**[Back]:** For moving to the previous step or layer in the navigation structure.

**Arrows [▲] [▼]:** For maneuvering between parameter groups, parameters and within parameters.

**[OK]:** For selecting a parameter and for accepting changes to parameter settings.

**Operation Keys:**

A yellow light above the operation keys indicates the active key.

**[Hand on]:** Starts the motor and enables control of the frequency converter via the LCP.

**[Off/Reset]:** The motor stops except in alarm mode. In that case the motor will be reset.

**[Auto on]:** The frequency converter is controlled either via control terminals or serial communication.

**[Potentiometer] (LCP12):** The potentiometer works in two ways depending on the mode in which the frequency converter is running.

In *Auto Mode* the potentiometer acts as an extra programmable analog input.

In *Hand on Mode* the potentiometer controls local reference.

## 4.2 Status Menu

After power up the Status Menu is active. Use the [MENU] key to toggle between Status, Quick Menu and Main Menu.

Arrows [▲] and [▼] toggles between the choices in each menu.

The display indicates the status mode with a small arrow above "Status".

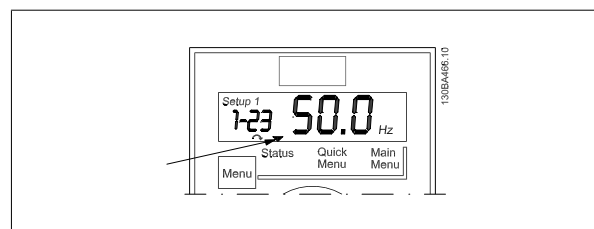

Illustration 4.8: Indicating Status mode

## 4.3 Quick Menu

The Quick Menu gives easy access to the most frequently used parameters.

1. To enter the Quick Menu, press [MENU] key until indicator in display is placed above *Quick Menu*.
2. Use [▲] [▼] to select either QM1 or QM2, then press [OK].
3. Use [▲] [▼] to browse through the parameters in the Quick Menu.
4. Press [OK] to select a parameter.
5. Use [▲] [▼] to change the value of a parameter setting.
6. Press [OK] to accept the change.
7. To exit, press either [Back] twice to enter *Status*, or press [Menu] once to enter *Main Menu*.

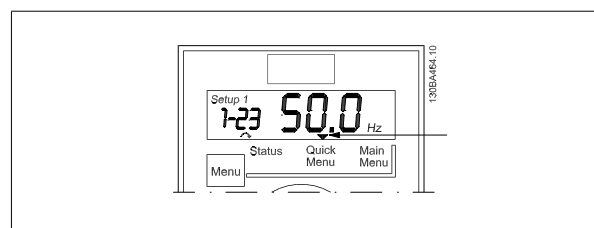

Illustration 4.9: Indicating Quick Menu mode

## 4.4 Quick Menu Parameters

### 4.4.1 Quick Menu Parameters - Basic Settings QM1

Below are descriptions of all parameters found in the Quick Menu.

\* = Factory setting.

# 4

#### 1-20 Motor Power [kW]/[HP] ( $P_{m,n}$ )

**Option:**

**Function:**

Enter motor power from nameplate data.

Two sizes down, one size up from nominal VLT rating.

[1]	0.09 kW/0.12 HP
[2]	0.12 kW/0.16 HP
[3]	0.18kW/0.25 HP
[4]	0.25 kW/0.33 HP
[5]	0.37kW/0.50 HP
[6]	0.55 kW/0.75 HP
[7]	0.75 kW/1.00 HP
[8]	1.10 kW/1.50 HP
[9]	1.50 kW/2.00 HP
[10]	2.20 kW/3.00 HP
[11]	3.00 kW/4.00 HP
[12]	3.70 kW/5.00 HP
[13]	4.00 kW/5.40 HP
[14]	5.50 kW/7.50 HP
[15]	7.50 kW/10.0 HP
[16]	11.00 kW/15.00 HP



**NB!**

Changing this parameter affects par. 1-22 to 1-25, 1-30, 1-33 and 1-35.

#### 1-22 Motor Voltage ( $U_{m,n}$ )

**Range:**

230/400 V [50 - 999 V]

**Function:**

Enter motor voltage from nameplate data.

#### 1-23 Motor Frequency ( $f_{m,n}$ )

**Range:**

50 Hz\* [20-400 Hz]

**Function:**

Enter motor frequency from nameplate data.

**1-24 Motor Current (I<sub>m.n</sub>)**

**Range:** M-type de- [0.01 - 26.00 A]  
pendent\*

**Function:** Enter motor current from nameplate data.

**1-25 Motor Nominal Speed (n<sub>m.n</sub>)**

**Range:** M-type De- [100 - 9999 RPM]  
pendent\*

**Function:** Enter motor nominal speed from nameplate data.

**1-29 Automatic Motor Tuning (AMT)**

**Option:**

**Function:** Use AMT to optimize motor performance.



**NB!**  
This parameter cannot be changed while motor runs.

1. Stop the frequency converter – make sure motor is at standstill
2. Choose [2] Enable AMT
3. Apply start signal
  - Via LCP: Press Hand On
  - Or in Remote On mode: Apply start signal on terminal 18

[0] \* Off AMT function is disabled.

[2] Enable AMT AMT function starts running.



**NB!**  
To gain optimum tuning of frequency converter, run AMT on a cold motor.

**3-02 Minimum Reference**

**Range:** 0.00\* [-4999 - 4999]

**Function:** Enter value for minimum reference.  
The sum of all internal and external references are clamped (limited) to the minimum reference value, par. 3-02.

**3-03 Maximum Reference**

**Range:** 50.00\* [-4999 - 4999]

**Function:** Maximum Reference is adjustable in the range Minimum Reference - 4999.  
Enter value for Maximum Reference.  
The sum of all internal and external references are clamped (limited) to the maximum reference value, par. 3-03.

### 3-41 Ramp1 Ramp-up Time

**Range:**

3.00 s\* [0.05 - 3600.00 s]

**Function:**

Enter ramp-up time from 0 Hz to rated motor frequency ( $f_{M,N}$ ) set in par. 1-23.  
Choose a ramp-up time ensuring that torque limit is not exceeded, see par. 4-16.

### 3-42 Ramp1 Ramp-down Time

**Range:**

3.00\* [0.05 - 3600.00 s]

**Function:**

Enter ramp down time from rated motor frequency ( $f_{M,N}$ ) in par. 1-23 to 0 Hz.  
Choose a ramp down time that does not cause over-voltage in inverter due to regenerative operation of motor. Furthermore, regenerative torque must not exceed limit set in par. 4-17.

## 4.4.2 Quick Menu Parameters - PI Basic Settings QM2

The following is a brief description of the parameters for the PI Basic Settings. For a more detailed description, please see *VLT Micro Drive Programming Guide*, MG.02.CX.YY.

### 1-00 Configuration Mode

**Range:**

[]

**Function:**

Choose [3] Process Closed Loop

### 3-02 Min. Reference

**Range:**

[-4999 - 4999]

**Function:**

Sets limits for set-point and feedback.

### 3-03 Max. Reference

**Range:**

[-4999 - 4999]

**Function:**

Sets limits for set-point and feedback.

### 3-10 Preset Reference

**Range:**

[-100.00 - 100.00]

**Function:**

Preset [0] works as set-point.

### 4-12 Motor Speed Low Limit

**Range:**

[0.0 - 400 Hz]

**Function:**

Lowest possible output frequency.

### 4-14 Motor Speed High Limit

**Range:**

[0.0 - 400.00 Hz]

**Function:**

Highest possible output frequency.

**NB!**

Default 65 Hz should normally be reduced to 50 - 55 Hz.

**6-22 Terminal 60 Low Current****Range:**

[0.00 - 19.99 mA]

**Function:**

Normally set to 0 or 4 mA.

**6-23 Terminal 60 High Current****Range:**

[0.01 - 20.00 mA]

**Function:**

Normally (default) set to 20 mA.

**6-24 Terminal 60 Low Feedback Value****Range:**

[-4999 - 4999]

**Function:**

Value corresponding to P. 6-22 setting.

**6-25 Terminal 60 High Feedback Value****Range:**

[-4999 - 4999]

**Function:**

Value corresponding to P. 6-23 setting.

**6-26 Terminal 60 Filter Time Constant****Range:**

[0.01 - 10.00 s]

**Function:**

Filter for suppressing electrical noise.

**7-20 Process CL Feedback Resource****Range:**

[]

**Function:**

Choose [2] analog input 60.

**7-30 Process PI Normal/Inverse****Range:**

[]

**Function:**

Most PI controllers are "Normal".

**7-31 Process PI Anti Windup****Range:**

[]

**Function:**Leave *Enabled* normally.**7-32 Process PI Start Speed****Range:**

[0.0 - 200.0 Hz]

**Function:**

Choose expected normal running speed.

**7-33 Process PI Proportional Gain****Range:**

[0.00 - 10.00]

**Function:**

Enter the P-factor.

**7-34 Process PI Integral Time****Range:**

[0.10 - 9999.00 s]

**Function:**

Enter the I-factor.

### 7-38 Process Feed Forward Factor

**Range:**

[0 - 400%]

**Function:**

Only applicable with changing set-points.

## 4.5 Main Menu

The Main Menu gives access to all parameters.

# 4

1. To enter the Main Menu, press [MENU] key until indicator in display is placed above *Main Menu*.
2. Use [▲] [▼] to browse through the parameter groups.
3. Press [OK] to select a parameter group.
4. Use [▲] [▼] to browse through the parameters in the specific group.
5. Press [OK] to select the parameter.
6. Use [▲] [▼] to set/change the parameter value.
7. Press [OK] to accept the value.
8. To exit, press either [Back] twice to enter *Quick Menu*, or press [Menu] once to enter *Status*.

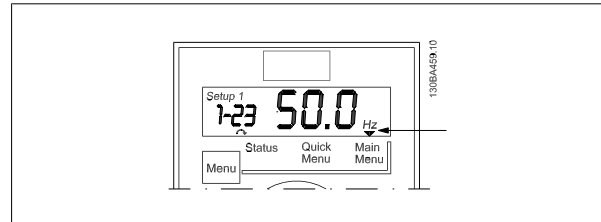

Illustration 4.10: Indicating Main Menu mode



## 5 Modbus RTU

### 5.1 Modbus RTU Overview

#### 5.1.1 Assumptions

These operating instructions assume that the installed controller supports the interfaces in this document and that all the requirements stipulated in the controller, as well as the frequency converter, are strictly observed, along with all limitations therein.

#### 5.1.2 What the User Should Already Know

The Modbus RTU (Remote Terminal Unit) is designed to communicate with any controller that supports the interfaces defined in this document. It is assumed that the user has full knowledge of the capabilities and limitations of the controller.

**5**

#### 5.1.3 Modbus RTU Overview

Regardless of the type of physical communication networks, the Modbus RTU Overview describes the process a controller uses to request access to another device. This includes i.a. how it will respond to requests from another device, and how errors will be detected and reported. It also establishes a common format for the layout and contents of message fields.

During communications over a Modbus RTU network, the protocol determines how each controller will learn its device address, recognise a message addressed to it, determine the kind of action to be taken, and extract any data or other information contained in the message. If a reply is required, the controller will construct the reply message and send it.

Controllers communicate using a master-slave technique in which only one device (the master) can initiate transactions (called queries). The other devices (slaves) respond by supplying the requested data to the master, or by taking the action requested in the query.

The master can address individual slaves, or can initiate a broadcast message to all slaves. Slaves return a message (called a response) to queries that are addressed to them individually. No responses are returned to broadcast queries from the master. The Modbus RTU protocol establishes the format for the master's query by placing into it the device (or broadcast) address, a function code defining the requested action, any data to be sent, and an error-checking field. The slave's response message is also constructed using Modbus protocol. It contains fields confirming the action taken, any data to be returned, and an error-checking field. If an error occurs in receipt of the message, or if the slave is unable to perform the requested action, the slave will construct an error message and send it in response, or a time-out will occur.

#### 5.1.4 Frequency Converter with Modbus RTU

The frequency converter communicates in Modbus RTU format over the built-in RS-485 interface. Modbus RTU provides access to the Control Word and Bus Reference of the frequency converter.

The Control Word allows the Modbus master to control several important functions of the frequency converter:

- Start
- Stop of the frequency converter in various ways:
  - Coast stop
  - Quick stop
  - DC Brake stop
  - Normal (ramp) stop
- Reset after a fault trip
- Run at a variety of preset speeds
- Run in reverse
- Change the active set-up
- Control the frequency converter's built-in relay

The Bus Reference is commonly used for speed control. It is also possible to access the parameters, read their values, and where possible, write values to them. This permits a range of control options, including controlling the setpoint of the frequency converter when its internal PI controller is used.

## 5.2 Modbus RTU Message Framing Structure

### 5.2.1 Remote Terminal Unit

The controllers are set up to communicate on the Modbus network using RTU (Remote Terminal Unit) mode, with each 8-bit byte in a message containing two 4-bit hexadecimal characters.

The format for each byte is shown below.

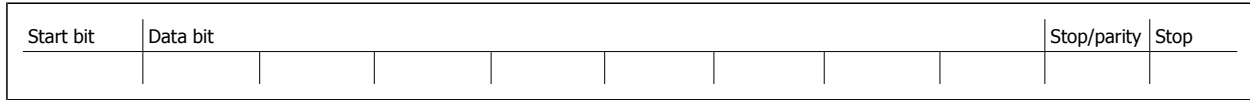

5

Coding system:	8-bit binary, hexadecimal 0-9, A-F. Two hexadecimal characters contained in each 8-bit field of the message.
Bits per byte:	1 start bit 8 data bits, least significant bit sent first Parity: 1 bit for even/odd parity is used; 1 or 2 stop bits if no parity is selected (see par. 8-33).
Error Check Field:	Cyclical Redundancy Check (CRC).

### 5.2.2 Modbus RTU Message Structure

The transmitting device places a Modbus RTU message into a frame with a known beginning and ending point. This allows receiving devices to begin at the start of the message, read the address portion, determine which device is addressed (or all devices, if the message is broadcast), and to recognise when the message is completed. Partial messages are detected and errors set as a result - or timeouts occur. Characters for transmission must be in hexadecimal 00 to FF format in each field.

The frequency converter continuously monitors the network bus, also during "silent" intervals. When the first field (the address field) is received, each frequency converter or device decodes it to determine which device is being addressed. Modbus RTU messages addressed to zero are broadcast messages. No response is permitted for broadcast messages. A typical message frame is shown below.

Start	Address	Function	Data	CRC check	End
T1-T2-T3-T4	1 byte	1 byte	N x 1 byte	2 bytes	T1-T2-T3-T4

Table 5.1: Typical Modbus RTU Message Structure

### 5.2.3 Start/Stop Field

Messages start with a silent period of at least 3.5 character intervals. This is implemented as a multiple of character intervals at the selected network baud rate (shown as Start T1-T2-T3-T4). The first field to be transmitted is the device address. Following the last transmitted character, a similar period of at least 3.5 character intervals marks the end of the message. A new message can begin after this period.

The entire message frame must be transmitted as a continuous stream. If a silent period of more than 1.5 character intervals occurs before completion of the frame, the receiving device flushes the incomplete message and assumes that the next byte will be the address field of a new message. Similarly, if a new message begins prior to 3.5 character intervals after a previous message, the receiving device will ignore both messages. This will cause a time-out (no response from the slave).

### 5.2.4 Address Field

The address field of a message frame contains 1 byte. Valid slave device addresses are in the range of 0 - 247 decimal. The individual slave devices are assigned addresses in the range of 1 - 247 (0 is reserved for broadcast mode, which all slaves recognise). A master addresses a slave by placing the slave address in the address field of the message.

When the slave sends its response, it places its own address in this address field to let the master know which slave is responding.

### 5.2.5 Function Field

The function field of a message frame contains 1 byte. Function fields are used to send messages between master and slave. When a message is sent from a master to a slave device, the function code field tells the slave what kind of action to perform. When the slave responds to the master, it uses the function code field to indicate either a normal (error-free) response, or that some kind of error occurred (called an exception response).

For a normal response, the slave simply echoes the original function code. For an exception response, the slave returns a code that is equivalent to the original code with its most significant bit set to logic 1. In addition, the slave places a unique code into the data field of the response message. This tells the master what kind of error occurred, or the reason for the exception. Please also refer to the sections *Function Codes Supported by Modbus RTU* and *Exception Codes*.

### 5.2.6 Data Field

The data field is constructed using sets of two hexadecimal digits in the range of 00 to FF hexadecimal. These are made up of one RTU character. The data field of messages sent from a master to a slave device contains additional information which the slave must use to take the action defined by the function code. This can include items such as addresses of coils or registers, the quantity of items to be handled, and the count of actual data bytes in the field.

### 5.2.7 CRC Check Field

Messages include an error-checking field, operating on the basis of a Cyclical Redundancy Check (CRC) method. The CRC field checks the content of the entire message. It is applied regardless of any parity check method used for the individual characters of the message.

The CRC value is calculated by the transmitting device, which appends the CRC as the last field in the message. The receiving device recalculates a CRC during receipt of the message and compares the calculated value to the actual value received in the CRC field. If the two values are unequal, a bus time-out occurs. The error-checking field contains a 16-bit binary value implemented as two 8-bit bytes. When this is done, the low-order byte of the field is appended first, followed by the high-order byte. The CRC high-order byte is the last byte sent in the message.

### 5.2.8 Coil/Register Addressing

In Modbus, all data are organised in coils and holding registers. Coils hold a single bit, whereas holding registers hold a 2-byte word (i.e. 16 bits). All data addresses in Modbus messages are referenced to zero. The first occurrence of a data item is addressed as item number zero.

Example:

The coil known as "coil 1" in programmable controller is addressed as coil 0000 in the data address field of a Modbus message. Coil 127 decimal is addressed as coil 007E<sub>HEX</sub> (126 decimal).

Holding register 40001 is addressed as register 0000 in the data address field of the message. The function code field already specifies a "holding register" operation. Therefore, the "4XXXX" reference is implicit. Holding register 40108 is addressed as register 006B<sub>HEX</sub> (107 decimal).

Coil number	Description	Signal direction
1 - 16	Frequency converter control word (see table below)	Master to slave
17 - 32	Frequency converter speed or set-point reference Range 0x0 - 0xFFFF (-200% ... ~ 200%)	Master to slave
33 - 48	Frequency converter status word (see table below)	Slave to master
49 - 64	Open loop mode: Frequency converter output frequency Closed loop mode: Frequency converter feedback signal	Slave to master
65	Parameter write control (master to slave) 0 = Parameter changes are written to the RAM of the frequency converter 1 = Parameter changes are written to the RAM and EEPROM of the frequency converter	Master to slave
66 - 65536	Reserved	

Coil	0	1
01	Preset reference LSB	
02	Preset reference MSB	
03	DC brake	No DC brake
04	Coast stop	No coast stop
05	Quick stop	No quick stop
06	Freeze outp	No freeze outp
07	Ramp stop	Start
08	No function	Reset
09	No jog	Jog
10	Ramp 1	Ramp 2
11	Data not valid	Data valid
12	Relay 1 off	Relay 1 on
13	Not used	Not used
14	Setup 1	Setup 2
15	Not used	Not used
16	No reversing	Reversing
Frequency converter control word (FC profile)		

Coil	0	1
33	Control not ready	Control ready
34	Unit not ready	Unit ready
35	Coasted	Not coasted
36		Error, tripped
37		Error, no trip
38	Not used	Not used
39		Error, trip locked
40	No warning	Warning
41	Not on reference	On reference
42	Hand mode	Auto mode
43	Out of freq. range	In frequency range
44	Not running	Running
45	No res. brake fault	Resistor brake fault
46	No voltage warning	Voltage warning
47	Not in current limit	Current limit
48	No thermal warning	Thermal warning
Frequency converter status word (FC profile)		

Register number	Description
00001 – 00006	Reserved
00007	Last error code. See section <i>Exception and Error Codes</i> .
00008	Reserved
00009	Parameter index*
00100 – 00999	000 parameter group (parameters 001 through 099)
01000 – 01999	100 parameter group (parameters 100 through 199)
02000 – 02999	200 parameter group (parameters 200 through 299)
03000 – 03999	300 parameter group (parameters 300 through 399)
04000 – 04999	400 parameter group (parameters 400 through 499)
...	...
49000 – 49999	4900 parameter group (parameters 4900 through 4999)
50000	Input data: Frequency converter control word register (CTW).
50010	Input data: Bus reference register (REF).
...	...
50200	Output data: Frequency converter status word register (STW).
50210	Output data: Frequency converter main actual value register (MAV).

Table 5.1: Holding Registers

\* Used to specify the index number to be used when accessing an indexed parameter

## 5.3 How to Control the frequency converter

This section describes codes which can be used in the function and data fields of a Modbus RTU message. For a complete description of all the message fields please refer to the section *Modbus RTU Message Framing Structure*.

### 5.3.1 Function Codes Supported by Modbus RTU

Modbus RTU supports use of the following function codes in the function field of a message:

Function	Function Code
Read coils	1 hex
Read holding registers	3 hex
Write single coil	5 hex
Write single register	6 hex
Write multiple coils	F hex
Write multiple registers	10 hex
Get comm. event counter	B hex
Report slave ID	11 hex

Function	Function code	Sub-function code	Sub-function
Diagnostics	8	1	Restart communication
		2	Return diagnostic register
		10	Clear counters and diagnostic register
		11	Return bus message count
		12	Return bus communication error count
		13	Return bus exception error count
		14	Return slave message count

### 5.3.2 Exception and Error Codes

In the event of an error, the following exception codes may appear in the data field of a response message. For a full explanation of the structure of an exception (i.e. error) response, please refer to *Function Field* in section *Modbus RTU Message Framing Structure*.

MODBUS Exception Codes		
Code	Name	Meaning
1	Illegal function	The function code received in the query is not an allowable action for the server (or slave). This may be because the function code is only applicable to newer devices, and was not implemented in the unit selected. It could also indicate that the server (or slave) is in the wrong state to process a request of this type, for example it is not configured and is being asked to return register values.
2	Illegal data address	The data address received in the query is not an allowable address for the server (or slave). More specifically, the combination of reference number and transfer length is invalid. For a controller with 100 registers, a register with offset 96 and length 4 would succeed, a request with offset 96 and length 5 will generate exception 02.
3	Illegal data value	A value contained in the query data field is not an allowable value for server (or slave). This indicates a fault in the structure of the remainder of a complex request, such as an incorrect implied length. It specifically does NOT mean that a data item submitted for storage in a register has a value outside the expectation of the application program, since the MODBUS protocol is unaware of the significance of any particular value of any particular register.
4	Slave device failure	An unrecoverable error occurred while the server (or slave) was attempting to perform the requested action

In case of an exception code 4 while accessing parameter values in the drive, detailed information about the latest exception can be read from the drives Holding Register 0007. This register may contain one of the following, detailed error codes regarding the latest occurring MODBUS Exception.

Error code in holding register 0007	Description
00	The parameter number does not exist
01	There is no write access to the parameter
02	The data value exceeds the parameter limits
03	The sub-index in use does not exist
05	The data type does not match the parameter called
17	Data change in the parameter called is not possible in the present mode
18	Other error
130	There is no bus access to the parameter called

## 5.4 How to Access Parameters

### 5

### 5.4.1 Parameter Handling

The PNU (Parameter Number) is translated from the register address contained in the Modbus read or write message. The parameter number is translated to Modbus register address as  $(10 \times \text{parameter number} - 1)_{\text{DECIMAL}}$ .

### 5.4.2 Storage of Data

The Coil 65 decimal determines whether data written to the frequency converter are stored in EEPROM and RAM (coil 65 = 1) or only in RAM (coil 65 = 0).

### 5.4.3 IND

The array index is set in Holding Register 9 and used when accessing array parameters.

### 5.4.4 Text Blocks

Parameters stored as text strings are accessed in the same way as the other parameters. The maximum text block size is 20 characters. If a read request for a parameter is for more characters than the parameter stores, the response is truncated. If the read request for a parameter is for fewer characters than the parameter stores, the response is space filled.

### 5.4.5 Conversion Factor

The different attributes for each parameter can be seen in the section on factory settings. Since a parameter value can only be transferred as a whole number, a conversion factor must be used to transfer decimals. Please refer to the section *Conversion Index*.

### 5.4.6 Parameter Values

#### Standard Data Type

Standard data types are int16, int32, uint8, uint16 and uint32. They are stored as 4x registers (40001 - 4FFFF). The parameters are read using function 03<sub>HEX</sub> "Read Holding Registers". Parameters are written using the function 06<sub>HEX</sub> "Preset Single Register" for 1 register (16 bits), and the function 10<sub>HEX</sub> "Preset Multiple Registers" for 2 registers (32 bits). Readable sizes range from 1 register (16 bits) up to 10 registers (20 characters).

#### Non Standard Data Types

Non standard data types are text strings and are stored as 4x registers (40001 - 4FFFF). The parameters are read using function 03<sub>HEX</sub> "Read Holding Registers" and written using function 10<sub>HEX</sub> "Preset Multiple Registers". Readable sizes range from 1 register (2 characters) up to 10 registers (20 characters).

## 5.5 Examples

The following examples illustrate various Modbus RTU commands. If an error occurs, please refer to the *Exception Codes* section.

### 5.5.1 Read Coil Status (01<sub>HEX</sub>)

#### Description

This function reads the ON/OFF status of discrete outputs (coils) in the frequency converter. Broadcast is never supported for reads.

#### Query

The query messages specifies the starting coil and quantity of coils to be read. Coil addresses start at zero, i.e. coil 33 is addressed as 32.

Example of a request to read coils 33-48 (Status Word) from slave device

01:

Field Name	Example (HEX)
Slave address	01 (frequency converter address)
Function	01 (read address)
Starting Address HI	00
Starting Address LO	20 (32 decimal)
No. of Points HI	00
No. of Points LO	10 (16 decimal)
Error Check (CRC)	-

#### Response

The coil status in the response message is packed as one coil per bit of the data field. Status is indicated as: 1 = ON; 0 = OFF.

The LSB of the first data byte contains the coil addressed in the query. The other coils follow toward the high order end of this byte, and from "low order to high order" in subsequent bytes.

If the returned coil quantity is not a multiple of eight, the remaining bits in the final data byte will padded with zeros (toward the high order and of the byte). The Byte Count field specifies the number of complete bytes of data.

Field Name	Example (HEX)
Slave address	01 (frequency converter address)
Function	01 (read coils)
Byte count	02 (2 bytes of data)
Data (Coils 40-33)	07
Data (Coils 48-41)	06 (STW = 0607hex)
Error Check (CRC)	-

### 5.5.2 Force/Write Single Coil (05<sub>HEX</sub>)

#### Description

This function forces a coil to either ON or OFF. When broadcast the function forces the same coil references in all attached slaves.

#### Query

The query message specifies the coil 65 (parameter write control) to be forced. Coil addresses start at zero, i.e. coil 65 is addressed as 64. Force Data = 00 00HEX (OFF) or FF 00HEX (ON).

Field Name	Example (HEX)
Slave address	01 (frequency converter address)
Function	05 (write single coil)
Coil Address HI	00
Coil Address LO	40 (coil no. 65)
Force Data HI	FF
Force Data LO	00 (FF 00 = ON)
Error Check (CRC)	-

#### Response

The normal response is an echo of the query, returned after the coil state has been forced.

Field Name	Example (HEX)
Slave address	01
Function	05
Coil Address HI	00
Coil Address LO	40
Data HI	FF
Data LO	00
Error Check (CRC)	-

### 5.5.3 Force/Write Multiple Coils (0F<sub>HEX</sub>)

5

#### Description

This function forces each coil in a sequence of coils to either ON or OFF. When broadcast the function forces the same coil references in all attached slaves.

#### Query

The query message specifies the coils 17 to 32 (speed set-point) to be forced. Coil addresses start at zero, i.e. coil 17 is addressed as 16.

Field Name	Example (HEX)
Slave address	01 (frequency converter address)
Function	0F (write multiple coil)
Coil Address HI	00
Coil Address LO	10 (coil address 17)
Quantity of coils HI	00
Quantity of coils LO	10 (16 coils)
Byte count	02
Force Data HI (coils 8-1)	20
Force Data LO (coils 10-9)	00 (ref. = 2000hex)
Error Check (CRC)	-

#### Response

The normal response returns the slave address, function code, starting address, and quantity of coils forced.

Field Name	Example (HEX)
Slave address	01 (frequency converter address)
Function	0F (write multiple coils)
Coil Address HI	00
Coil Address LO	10 (coil address 17)
Quantity of coils HI	00
Quantity of coils LO	10 (16 coils)
Error Check (CRC)	-

### 5.5.4 Read Holding Registers (03<sub>HEX</sub>)

#### Description

This function reads the content of holding registers in the slave.

#### Query

The query message specifies the starting register and quantity to be read. Register addresses start at zero, i.e. registers 1-4 are addressed as 0-3.



**Example**

Read PNU 342 which is mapped to register 0x0D5B(RegAdr = 342 x 10 - 1)

Field Name	Example (HEX)
Slave address	01
Function	03
Starting Address HI	0D
Starting Address LO	5B
No. of Points HI	00
No. of Points LO	02
Error Check (CRC)	-

Table 5.1: Request frame

**Response**

The register data in the response message are packed as two bytes per register, with the binary contents right justified within each byte. For each register, the first byte contains the high order bits and the second contains the low order bits.



Field Name	Example (HEX)
Slave address	01
Function	03
Byte count	04
Data HI (Register 3419)	00
Data LO (Register 3419)	00
Data HI (Register 3420)	00
Data LO (Register 3420)	03
Error Check (CRC)	-

Table 5.1: Normal response frame

### 5.5.5 Preset Single Register (06<sub>HEX</sub>)

**Description**

This function presets a value into a single holding register.

**Query**

The query message specifies the register reference to be preset. Register addresses start at zero, i.e. register 1 is addressed as 0.

**Example**

Write 1 to PNU3 which is mapped to register 0x001D (3 x 10-1 = 29 = 001DHex)

Field Name	Example (HEX)
Slave address	01
Function	06
Starting Address HI	00
Starting Address LO	1D
No. of Points HI	00
No. of Points LO	01
Error Check (CRC)	-

Table 5.1: Request frame

**Response**

The normal response is an echo of the query, returned after the register contents have been passed.

Field Name	Example (HEX)
Slave address	01
Function	06
Starting Address HI	00
Starting Address LO	1D
No. of Points HI	00
No. of Points LO	01
Error Check (CRC)	-

Table 5.1: Normal response frame

## 5

**5.5.6 Preset Multiple Registers (10<sub>HEX</sub>)****Description**

This function presets a value into a sequence of holding registers.

**Query**

The query message specifies the register references to be preset. Register addresses start at zero, i.e. register 1 is addressed as 0.

**Example**

Write 65535 (655.35s) to PNU734 (4-bytes) mapped to 0 x 1CAB

Field Name	Example (HEX)
Slave address	01
Function	10
Starting Address HI	1C
Starting Address LO	AB
No. of Registers HI	00
No. of Registers LO	02
Byte count	04
Write Data HI (Register 7339)	00
Write Data LO (Register 7339)	00
Write Data HI (Register 7340)	FF
Write Data LO (Register 7340)	FF
Error Check (CRC)	-

Table 5.1: Request frame

**Response**

The normal response returns the slave address, function code, starting address, and quantity of registers preset.

Field Name	Example (HEX)
Slave address	01
Function	10
Starting Address HI	1C
Starting Address LO	AB
No. of Registers HI	00
No. of Registers LO	02
Error Check (CRC)	-

Table 5.1: Normal response frame

## 5.6 Danfoss FC Control Profile

### 5.6.1 Control Word According to FC Profile

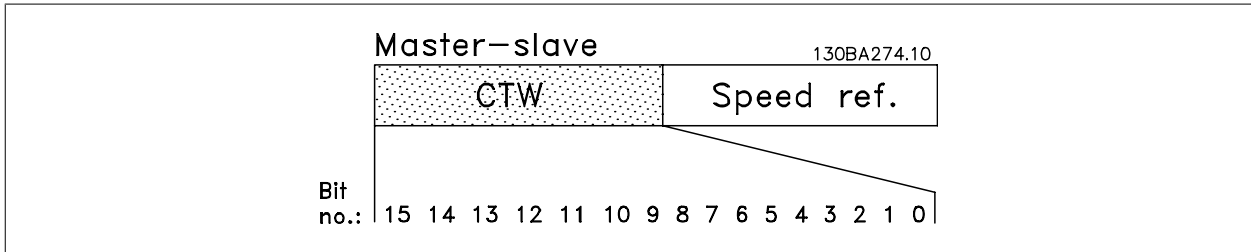

Bit	Bit value = 0	Bit value = 1
00	Preset reference select - lsb	Preset reference select - lsb
01	Preset reference select - msb	Preset reference select - msb
02	DC brake	Ramp
03	Coasting	No coasting
04	Quick stop	Ramp
05	Freeze output	No freeze output
06	Ramp stop	Start
07	No function	Reset
08	No function	Jog
09	Ramp 1	Ramp 2
10	Data invalid	Data valid
11	No function	Relay 01 active
12	No function	No function
13	Setup 1	Setup 2
14	No function	No function
15	No function	Reverse

5

### 5.6.2 Explanation of the Control Bits

Bits 00/01

Bits 00 and 01 are used to choose between the four reference values, which are pre-programmed in par. 3-10 *Preset Reference* according to the following table:

Programmed ref. value	Parameter	Bit 01	Bit 02
1	3-10 [0]	0	0
2	3-10 [1]	0	1
3	3-10 [2]	1	0
4	3-10 [3]	1	1

**NB!**  
In par. 8-56 *Preset reference* a selection is made to define how Bit 00/01 gates with the corresponding function on the digital inputs.

Bit 02, DC brake:

Bit 02 = "0" leads to DC braking and stop. Braking current and duration are set in par. 2-01 *DC Brake current* and 2-02 *Braking time*.

Bit 02 = "1" leads to ramping.

**Bit 03, Coasting:**

Bit 03 = "0" shuts off the output transistors causing the motor to coast to a standstill.

Bit 03 = "1" enables the frequency converter to start the motor if the other starting conditions have been fulfilled.

**NB!**

In par. 8-50 *Coasting select* a selection is made to define how Bit 03 gates with the corresponding function on a digital input.

**Bit 04, Quick stop:**

Bit 04 = "0" causes a stop, in which the motor speed is ramped down to stop via 9ar. 3-81 *Quick stop ramp time*.

**Bit 05, Hold output frequency:**

Bit 05 = "0" causes the present output frequency (in Hz) to freeze. The frozen output frequency can then be changed only by means of the digital inputs (par. 5-10 to 5-15) programmed to *Speed up* and *Speed down*.

5

**NB!**

If *Freeze output* is active, the frequency converter can only be stopped by the following:

- Bit 03 Coasting stop
- Bit 02 DC braking
- Digital input (par. 5-10 to 5-15) programmed to *DC braking*, *Coasting stop* or *Reset and coasting stop*.

**Bit 06, Ramp stop/start:**

Bit 06 = "0" causes a stop, in which the motor speed is ramped down to stop via the selected ramp down parameter.

Bit 06 = "1" permits the frequency converter to start the motor, if the other starting conditions have been fulfilled.

**NB!**

In par. 8-53 *Start select* a selection is made to define how Bit 06 *Ramp stop/start* gates with the corresponding function on a digital input.

**Bit 07, Reset:**

Bit 07 = "0" does not cause a reset.

Bit 07 = "1" causes the reset of a trip. Reset is activated on the signal's leading edge, i.e. when changing from logic "0" to logic "1".

**Bit 08, Jog:**

Bit 08 = "1" causes the output frequency to be determined by par. 3-19 *Jog speed*.

**Bit 09, Selection of ramp 1/2:**

Bit 09 = "0" means the ramp 1 is active (par. 3-40 to 3-47).

Bit 09 = "1" means that ramp 2 (par. 3-50 to 3-57) is active.

**Bit 10, Data not valid/Data valid:**

Is used to tell the frequency converter whether the control word is to be used or ignored.

Bit 10 = "0" causes the control word to be ignored.

Bit 10 = "1" causes the control word to be used.

**Bit 11, Relay 01:**

Bit 11 = "0" Relay 01 not activated

Bit 11 = "1" Relay 01 is activated, provided *Control word Bit 11* has been chosen in par. 5-40 *Function relay*.

**Bit 12:**  
Not used.

**Bit 13, Selection of set-up:**  
Bit 13 = is used to choose the active set-up. The function is only possible when *Multi set-ups* is selected in par. 0-10 *Active Set-up*.



**NB!**  
In par. 8-55 *Set-up select* a selection is made to define how Bit 13 gates with the corresponding function on the digital inputs.

**Bit 14:**  
Not used.

**Bit 15, Reverse:**  
Bit 15 = "0" causes no reversing.  
Bit 15 = "1" causes reversing.



**NB!**  
Depends on par. 8-54 *Reversing select*.

### 5.6.3 Status Word According to FC Profile (STW)

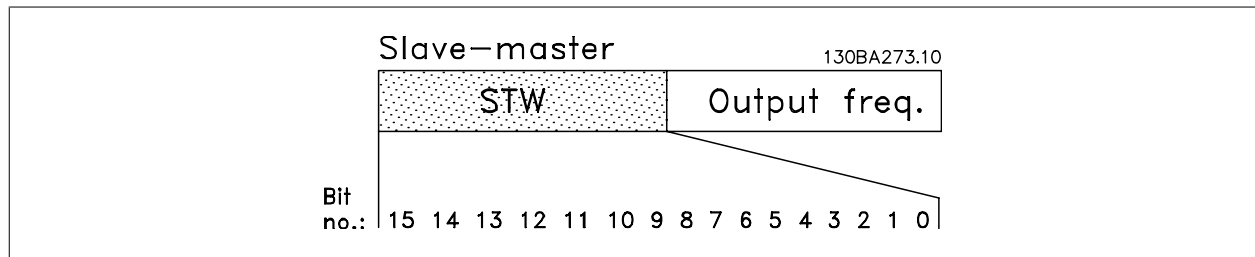

Bit	Bit value = 0	Bit value = 1
00	Control not ready	Control ready
01	Unit not ready	Unit ready
02	Coasting	Enable
03	No error	Error, trip
04	No error	Error (no trip)
05	Reserved	-
06	Not trip locked	Trip locked
07	No warning	Warning
08	Speed ≠ reference	Speed = reference
09	Local operation	Bus control
10	Out of frequency limit	Frequency limit OK
11	Not running	Running
12	No resistor brake fault	Resistor brake fault
13	Voltage OK	Voltage exceeded
14	Torque OK	Torque exceeded
15	No thermal warning	Thermal warning

## 5.6.4 Explanation of the Status Bits

### Bit 00, Control not ready/ready:

Bit 00 = "0" means that the frequency converter has tripped.

Bit 00 = "1" means that the frequency converter controls are ready, but that the power component is not necessarily receiving any power supply (in case of external 24 V supply to controls).

### Bit 01, Frequency converter ready:

Bit 01 = "1". The frequency converter is ready for operation, but there is an active coasting command via the digital inputs or via serial communication.

### Bit 02, Coasting stop:

Bit 02 = "0". The frequency converter released the motor.

Bit 02 = "1". The frequency converter can start the motor when a start command is given.

### Bit 03, No error/trip:

Bit 03 = "0" means that the frequency converter is not in fault mode.

Bit 03 = "1" means that the frequency converter is tripped, and that a reset signal is required to re-establish operation.

### Bit 04, No error/error (trip):

Bit 04 = "0" means that the frequency converter is not in fault mode.

Bit 04 = "1" means that there is a frequency converter error but no trip.

### Bit 05:

Not used.

### Bit 06, No error/trip lock:

Bit 06 = "0" means that the frequency converter is not in fault mode.

Bit 06 = "1" means that the frequency converter is tripped and locked.

### Bit 07, No warning/warning:

Bit 07 = "0" means that there are no warnings.

Bit 07 = "1" means that a warning has occurred.

### Bit 08, Speed ≠ reference/speed = reference:

Bit 08 = "0" means that the motor is running, but that the present speed is different from the preset speed reference. For example, this might occur while the speed is being ramped up/down during start/stop.

Bit 08 = "1" means that the present motor speed matches the preset speed reference.

### Bit 09, Local operation/bus control:

Bit 09 = "0" means that [Stop/Reset] is activated on the control unit. It is not possible to control the frequency converter via serial communication.

Bit 09 = "1" means that it is possible to control the frequency converter via serial communication.

### Bit 10, Out of frequency limit:

Bit 10 = "0", if the output frequency has reached the value in par. 4-12 *Motor speed low limit* or par. 4-13 *Motor speed high limit*.

Bit 10 = "1" means that the output frequency is within the defined limits.

### Bit 11, Running:

Bit 11 = "0" means that the motor is not running.

Bit 11 = "1" means that the frequency converter has a start signal or that the output frequency is higher than 0 Hz.

### Bit 12, Resistor brake fault:

Bit 12 = "0" means that there is no resistor brake fault.

Bit 12 = "1" means that there is a resistor brake fault.

**Bit 13, Voltage OK/limit exceeded:**

Bit 13 = "0" means that there are no voltage warnings.

Bit 13 = "1" means that the DC voltage in the frequency converter's intermediate circuit is too low or too high.

**Bit 14, Torque OK/limit exceeded:**

Bit 14 = "0" means that there are no current/torque warnings or errors.

Bit 14 = "1" means that there is a current/torque warning or error.

**Bit 15, Thermal warning:**

Bit 15 = "0" means that there is no thermal warning or error.

Bit 15 = "1" means that one of the thermal limits has been exceeded.

### 5.6.5 Bus Speed Reference Value

The speed reference value is transmitted to the frequency converter in a relative value in %.

The value is transmitted in the form of a 16-bit word; in integers (0-32767) the value 16384 (4000 Hex) corresponds to 100%. Negative figures are formatted by means of 2's complement.

The Actual Output Frequency (MAV) is scaled in the same way as the bus reference.

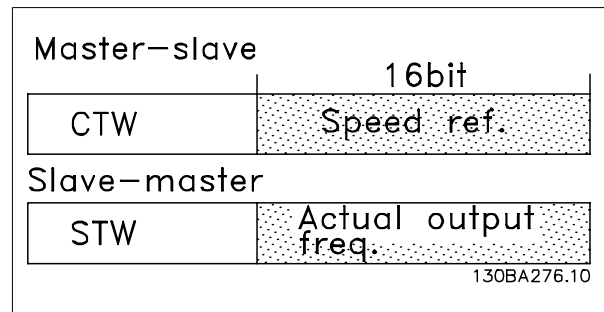

The reference and MAV are scaled as follows:

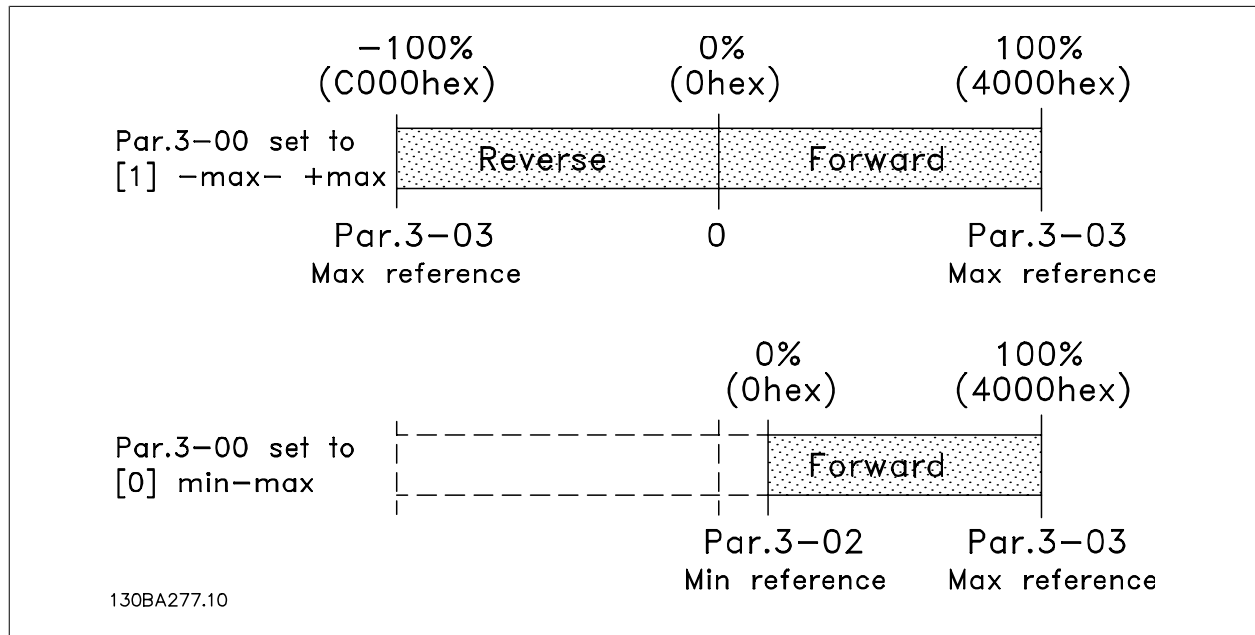

6



# 6 Parameter Overview

Parameter Overview	
<b>0-** Operation/Display</b>	
<b>0-0* Basic Settings</b>	
<b>0-03 Regional Settings</b>	
*[0] International	
[1] US	
<b>0-04 Oper. State at Power-up (Hand)</b>	
[0] Resume	
*[1] Forced stop, ref = old	
[2] Forced stop, ref = 0	
<b>0-1* Set-up Handling</b>	
<b>0-10 Active Set-up</b>	
*[1] Setup 1	
[2] Setup 2	
[9] Multi Setup	
<b>0-11 Edit Set-up</b>	
*[1] Setup 1	
[2] Setup 2	
[9] Active Setup	
<b>0-12 Link Setups</b>	
[0] Not Linked	
*[20] Linked	
<b>0-31 Custom Readout Min Scale</b>	
0.00 - 9999.00	
*0.00	
<b>0-32 Custom Readout Max Scale</b>	
0.00 - 9999.00	
*100.0	
<b>0-4* LCP Keypad</b>	
<b>0-40 [Hand on] Key on LCP</b>	
[0] Disabled	
*[1] Enabled	
<b>0-41 [Off / Reset] Key on LCP</b>	
[0] Disable All	
*[1] Enable All	
[2] Enable Reset Only	
<b>0-42 [Auto on] Key on LCP</b>	
[0] Disabled	
*[1] Enabled	
<b>0-5* Copy/Save</b>	
<b>0-50 LCP Copy</b>	
*[0] No copy	
[1] All to LCP	
[2] All from LCP	
[3] Size indep. from LCP	
<b>0-51 Set-up Copy</b>	
*[0] No copy	
[1] Copy from setup 1	
[2] Copy from setup 2	
[9] Copy from Factory setup	
<b>0-6* Password</b>	
<b>0-60 (Main) Menu Password</b>	
0 - 999 * 0	
<b>1-** Load/Motor</b>	
<b>1-0* General Settings</b>	
<b>1-00 Configuration Mode</b>	
*[0] Speed open loop	
[3] Process	
<b>1-01 Motor Control Principle</b>	
[0] U/f	
*[1] VVC+	
<b>1-03 Torque Characteristics</b>	
*[0] Constant torque	
[2] Automatic Energy Optim.	
<b>1-05 Local Mode Configuration</b>	
[0] Speed Open Loop	
*[2] As config in param. 1-00	
<b>1-2* Motor Data</b>	
<b>1-20 Motor Power [kW] [HP]</b>	
[1] 0.09 kW/0.12 HP	
[2] 0.12 kW/0.16 HP	
[3] 0.18 kW/0.25 HP	
[4] 0.25 kW/0.33 HP	
[5] 0.37 kW/0.50 HP	
[6] 0.55 kW/0.75 HP	
[7] 0.75 kW/1.00 HP	
[8] 1.10 kW/1.50 HP	
[9] 1.50 kW/2.00 HP	
[10] 2.20 kW/3.00 HP	
[11] 3.00 kW/4.00 HP	
[12] 3.70 kW/5.00 HP	
[13] 4.00 kW/5.40 HP	
[14] 5.50 kW/7.50 HP	
[15] 7.50 kW/10.00 HP	
[16] 11.00 kW/15.00 HP	
<b>1-22 Motor Voltage</b>	
50 - 999 V * 230 - 400 V	
<b>1-23 Motor Frequency</b>	
20 - 400 Hz * 50 Hz	
<b>1-24 Motor Current</b>	
0.01 - 26.00 A * Motor type dep.	
<b>1-25 Motor Nominal Speed</b>	
100 - 9999 rpm * Motor type dep.	
<b>1-29 Automatic Motor Tuning (AMT)</b>	
*[0] Off	
[2] Enable AMT	
<b>1-3* Adv. Motor Data</b>	
<b>1-30 Stator Resistance (Rs)</b>	
[Ohm] * Dep. on motor data	
<b>1-33 Stator Leakage Reactance (Xl)</b>	
[Ohm] * Dep. on motor data	
<b>1-35 Main Reactance (Xh)</b>	
[Ohm] * Dep. on motor data	
<b>1-5* Load Indep. Setting</b>	
<b>1-50 Motor Magnetisation at 0 Speed</b>	
0 - 300 % * 100 %	
<b>1-52 Min Speed Norm. Magnet. [Hz]</b>	
0.0 - 10.0 Hz * 0.0 Hz	
<b>1-55 U/f Characteristic - U</b>	
0 - 999.9 V	
<b>1-56 U/f Characteristic - F</b>	
0 - 400 Hz	
<b>1-6* Load Depen. Setting</b>	
<b>1-60 Low Speed Load Compensation</b>	
0 - 199 % * 100 %	
<b>1-61 High Speed Load Compensation</b>	
0 - 199 % * 100 %	
<b>1-62 Slip Compensation</b>	
-400 - 399 % * 100 %	
<b>1-63 Slip Compensation Time Constant</b>	
0.05 - 5.00 s * 0.10 s	
<b>1-7* Start Adjustments</b>	
<b>1-71 Start Delay</b>	
0.0 - 10.0 s * 0.0 s	
<b>1-72 Start Function</b>	
[0] DC hold / delay time	
[1] DC brake / delay time	
[2] Coast / delay time	
<b>1-73 Flying Start</b>	
*[0] Disabled	
[1] Enabled	
<b>1-8* Stop Adjustments</b>	
<b>1-80 Function at Stop</b>	
*[0] Coast	
[1] DC hold	
<b>1-82 Min Speed for Funct. at Stop [Hz]</b>	
0.0 - 20.0 Hz * 0.0 Hz	
<b>1-9* Motor Temperature</b>	
<b>1-90 Motor Thermal Protection</b>	
*[0] No protection	
[1] Thermistor warning	
[2] Thermistor trip	
[3] Etr warning	
[4] Etr trip	
<b>1-93 Thermistor Resource</b>	
*[0] None	
<b>2-0* DC-Brake</b>	
<b>2-00 DC Hold Current</b>	
0 - 150 % * 50 %	
<b>2-01 DC Brake Current</b>	
0 - 150 % * 50 %	
<b>2-02 DC Braking Time</b>	
0.0 - 60.0 s * 10.0 s	
<b>2-04 DC Brake Cut In Speed</b>	
0.0 - 400.0 Hz * 0.0 Hz	
<b>2-1* Brake Energy Funct.</b>	
<b>2-10 Brake Function</b>	
*[0] Off	
[1] Resistor brake	
[2] AC brake	
<b>2-11 Brake Resistor (ohm)</b>	
5 - 5000 * 5	
<b>2-16 AC Brake, Max current</b>	
0 - 150 % * 100 %	
<b>2-17 Over-voltage Control</b>	
*[0] Disabled	
[1] Enabled (not at stop)	
[2] Enabled	
<b>2-2* Mechanical Brake</b>	
<b>2-20 Release Brake Current</b>	
0.00 - 100.0 A * 0.00 A	
<b>2-22 Activate Brake Speed [Hz]</b>	
0.0 - 400.0 Hz * 0.0 Hz	
<b>3-** Reference / Ramps</b>	
<b>3-0* Reference Limits</b>	
<b>3-00 Reference Range</b>	
*[0] Min - Max	
[1] -Max - +Max	
<b>3-02 Minimum Reference</b>	
-4999 - 4999 * 0.000	
<b>3-03 Maximum Reference</b>	
-4999 - 4999 * 50.00	
<b>3-7* References</b>	
<b>3-10 Preset Reference</b>	
-100.0 - 100.0 % * 0.00 %	
<b>3-11 Jog Speed [Hz]</b>	
0.0 - 400.0 Hz * 5.0 Hz	
<b>3-12 Catch up/slow Down Value</b>	
0.00 - 100.0 % * 0.00 %	

<p><b>3-14 Preset Relative Reference</b> -100.0 - 100.0 % * 0.00 %</p> <p><b>3-15 Reference Resource 1</b> [0] No function *[1] Analog Input 53 [2] Analog input 60 [8] Pulse input 33 [11] Local bus ref [21] LCP Potentiometer</p> <p><b>3-16 Reference Resource 2</b> [0] No function [1] Analog Input 53 *[2] Analog input 60 [8] Pulse input 33 [11] Local bus ref [21] LCP Potentiometer</p> <p><b>3-17 Reference Resource 3</b> [0] No function [1] Analog Input 53 [2] Analog input 60 [8] Pulse input 33 *[11] Local bus ref [21] LCP Potentiometer</p> <p><b>3-18 Relative Scaling Ref. Resource</b> *[0] No function [1] Analog Input 53 [2] Analog input 60 [8] Pulse input 33 [11] Local bus ref [21] LCP Potentiometer</p> <p><b>3-4* Ramp 1</b></p> <p><b>3-40 Ramp 1 Type</b> *[0] Linear [2] Sine2 ramp</p> <p><b>3-41 Ramp 1 Ramp up Time</b> 0.05 - 3600 s * 3.00 s</p> <p><b>3-42 Ramp 1 Ramp Down Time</b> 0.05 - 3600 s * 3.00 s</p> <p><b>3-5* Ramp 2</b></p> <p><b>3-50 Ramp 2 Type</b> *[0] Linear [2] Sine2 ramp</p> <p><b>3-51 Ramp 2 Ramp up Time</b> 0.05 - 3600 s * 3.00 s</p> <p><b>3-52 Ramp 2 Ramp down Time</b> 0.05 - 3600 s * 3.00 s</p> <p><b>3-8* Other Ramps</b></p>	<p><b>3-80 Jog Ramp Time</b> 0.05 - 3600 s * 3.00 s</p> <p><b>3-81 Quick Stop Ramp Time</b> 0.05 - 3600 s * 3.00 s</p> <p><b>4-** Limits / Warnings</b></p> <p><b>4-1* Motor Limits</b></p> <p><b>4-10 Motor Speed Direction</b> [0] Clockwise [1] CounterClockwise *[2] Both</p> <p><b>4-12 Motor Speed Low Limit [Hz]</b> 0.0 - 400.0 Hz * 0.0 Hz</p> <p><b>4-14 Motor Speed High Limit [Hz]</b> 0.1 - 400.0 Hz * 65.0 Hz</p> <p><b>4-16 Torque Limit Motor Mode</b> 0 - 400 % * 150 %</p> <p><b>4-17 Torque Limit Generator Mode</b> 0 - 400 % * 100 %</p> <p><b>4-5* Adj. Warnings</b></p> <p><b>4-50 Warning Current Low</b> 0.00 - 26.00 A * 0.00 A</p> <p><b>4-51 Warning Current High</b> 0.00 - 26.00 A * 26.00 A</p> <p><b>4-58 Missing Motor Phase Function</b> [0] Off *[1] On</p> <p><b>4-6* Speed Bypass</b></p> <p><b>4-61 Bypass Speed From [Hz]</b> 0.0 - 400.0 Hz * 0.0 Hz</p> <p><b>4-63 Bypass Speed To [Hz]</b> 0.0 - 400.0 Hz * 0.0 Hz</p> <p><b>5-1* Digital Inputs</b></p> <p><b>5-10 Terminal 18 Digital Input</b> [0] No function [1] Reset [2] Coast inverse [3] Coast and reset inv. [4] Quick stop inverse [5] DC-brake inv. [6] Stop inv *[8] Start [9] Latched start [10] Reversing [11] Start reversing [12] Enable start forward [13] Enable start reverse [14] Jog</p>	<p><b>10-18 Preset ref bit 0-2</b> [19] Freeze reference [20] Freeze output [21] Speed up [22] Speed down [23] Setup select bit 0 [28] Catch up [29] Slow down [34] Ramp bit 0 [60] Counter A (up) [61] Counter A (down) [62] Reset counter A [63] Counter B (up) [64] Counter B (down) [65] ResetCounter B</p> <p><b>5-11 Terminal 19 Digital Input</b> See par. 5-10. * [10] Reversing</p> <p><b>5-12 Terminal 27 Digital Input</b> See par. 5-10. * [1] Reset</p> <p><b>5-13 Terminal 29 Digital Input</b> See par. 5-10. * [14] Jog</p> <p><b>5-15 Terminal 33 Digital Input</b> See par. 5-10. * [16] Preset ref bit 0</p> <p>[26] Precise Stop Inverse [27] Start, Precise Stop [32] Pulse Input</p> <p><b>5-4* Relays</b></p> <p><b>5-40 Function Relay</b> *[0] No operation [1] Control ready [2] Drive ready [3] Drive ready, Remote [4] Enable / No warning [5] Drive running [6] Running / No warning [7] Run in range / No warning [8] Run on ref / No warning [9] Alarm [10] Alarm or warning [12] Out of current range [13] Below current, low [14] Above current, high [21] Thermal warning [22] Ready, No thermal warning [23] Remote ready, No thermal warning [24] Ready, Voltage ok</p>	<p>[25] Reverse [26] Bus ok [28] Brake, NoWarn [29] Brake ready/NoFault [30] BrakeFault (IGBT) [32] Mech.brake control [36] Control word bit 11 [51] Local ref. active [52] Remote ref. active [53] No alarm [54] Start cmd active [55] Running reverse [56] Drive in hand mode [57] Drive in auto mode [60-63] Comparator 0-3 [70-73] Logic rule 0-3 [81] SL digital output B</p> <p><b>5-5* Pulse Input</b> 5-55 Terminal 33 Low Frequency 20 - 4999 Hz * 20 Hz 5-56 Terminal 33 High Frequency 21 - 5000 Hz * 5000 Hz 5-57 Term. 33 Low Ref./Feedb. Value -4999 - 4999 * 0.000 5-58 Term. 33 High Ref./Feedb. Value -4999 - 4999 * 50.000</p> <p><b>6-** Analog In/Out</b></p> <p><b>6-0* Analog I/O Mode</b> 6-00 Live Zero Timeout Time 1 - 99 s * 10 s 6-01 Live Zero TimeoutFunction *[0] Off [1] Freeze output [2] Stop [3] Jogging [4] Max speed [5] Stop and trip</p> <p><b>6-1* Analog Input 1</b> 6-10 Terminal 53 Low Voltage 0.00 - 9.99 V * 0.07 V 6-11 Terminal 53 High Voltage 0.01 - 10.00 V * 10.00 V 6-12 Terminal 53 Low Current 0.00 - 19.99 mA * 0.14 mA</p>
---	--	---	---

<p><b>6-13 Terminal 53 High Current</b> 0.01 - 20.00 mA * 20.00 mA</p> <p><b>6-14 Term. 53 Low Ref./Feedb. Value</b> -4999 - 4999 * 0.000</p> <p><b>6-15 Term. 53 High Ref./Feedb. Value</b> -4999 - 4999 * 50.000</p> <p><b>6-16 Terminal 53 Filter Time Constant</b> 0.01 - 10.00 s * 0.01 s</p> <p><b>6-19 Terminal 53 mode</b> *[0] Voltage mode [1] Current mode</p> <p><b>6-2* Analog Input 2</b></p> <p><b>6-22 Terminal 60 Low Current</b> 0.00 - 19.99 mA * 0.14 mA</p> <p><b>6-23 Terminal 60 High Current</b> 0.01 - 20.00 mA * 20.00 mA</p> <p><b>6-24 Term. 60 Low Ref./Feedb. Value</b> -4999 - 4999 * 0.000</p> <p><b>6-25 Term. 60 High Ref./Feedb. Value</b> -4999 - 4999 * 50.00</p> <p><b>6-26 Terminal 60 Filter Time Constant</b> 0.01 - 10.00 s * 0.01 s</p> <p><b>6-8* LCP potentiometer</b></p> <p><b>6-81 LCP potm. Low Reference</b> -4999 - 4999 * 0.000</p> <p><b>6-82 LCP potm. High Reference</b> -4999 - 4999 * 50.00</p> <p><b>6-9* Analog Output xx</b></p> <p><b>6-90 Terminal 42 Mode</b> *[0] 0-20 mA [1] 4-20 mA [2] Digital Output</p> <p><b>6-91 Terminal 42 Analog Output</b> *[0] No operation [10] Output Frequency [11] Reference [12] Feedback [13] Motor Current [16] Power [20] BusControl</p> <p><b>6-92 Terminal 42 Digital Output</b> See par. 5-40 *[0] No Operation [80] SL Digital Output A</p>	<p><b>6-93 Terminal 42 Output Min Scale</b> 0.00 - 200.0 % * 0.00 %</p> <p><b>6-94 Terminal 42 Output Max Scale</b> 0.00 - 200.0 % * 100.0 %</p> <p><b>7-** Controllers</b></p> <p><b>7-20 Process CL Feedback 1 Resource</b> *[0] NoFunction [1] Analog Input 53 [2] Analog input 60 [8] PulseInput33 [11] LocalBusRef</p> <p><b>7-3* Process PI</b></p> <p><b>Ctrl. 7-30 Process PI Normal/ Inverse Ctrl</b> *[0] Normal [1] Inverse</p> <p><b>7-31 Process PI Anti Windup</b> [0] Disable *[1] Enable</p> <p><b>7-32 Process PI Start Speed</b> 0.0 - 200.0 Hz * 0.0 Hz</p> <p><b>7-33 Process PI Proportional Gain</b> 0.00 - 10.00 * 0.01</p> <p><b>7-34 Process PI Integral Time</b> 0.10 - 9999 s * 9999 s</p> <p><b>7-38 Process PI Feed Forward Factor</b> 0 - 400 % * 0 %</p> <p><b>7-39 On Reference Bandwidth</b> 0 - 200 % * 5 %</p> <p><b>8-** Comm. and Options</b></p> <p><b>8-0* General Settings</b></p> <p><b>8-01 Control Site</b> *[0] Digital and ControlWord [1] Digital only [2] ControlWord only</p> <p><b>8-02 Control Word Source</b> [0] None *[1] FC RS485</p> <p><b>8-03 Control Word Timeout Time</b> 0.1 - 6500 s * 1.0 s</p> <p><b>8-04 Control Word Timeout Function</b> *[0] Off [1] Freeze Output [2] Stop [3] Jogging</p>	<p><b>8-9* Bus Jog / Feedback</b></p> <p><b>8-94 Bus feedback 1</b> 0x8000 - 0x7FFF * 0</p> <p><b>13-** Smart Logic</b></p> <p><b>13-0* SLC Settings</b></p> <p><b>13-00 SL Controller Mode</b> *[0] Off [1] On</p> <p><b>13-01 Start Event</b> [0] False [1] True [2] Running [3] InRange [4] OnReference [7] OutOfCurrentRange [8] BelowLow [9] AboveHigh [16] ThermalWarning [17] MainOutOfRange [18] Reversing [19] Warning [20] Alarm_Trip [21] Alarm_TripLock [22-25] Comparator 0-3 [26-29] LogicRule0-3 [33] DigitalInput_18 [34] DigitalInput_19 [35] DigitalInput_27 [36] DigitalInput_29 [38] DigitalInput_33 *[39] StartCommand [40] DriveStopped</p> <p><b>13-02 Stop Event</b> See par. 13-01 * [40] DriveStopped</p> <p><b>13-03 Reset SLC</b> *[0] Do not reset [1] Reset SLC</p> <p><b>13-1* Comparators</b></p>	<p>[4] Max Speed [5] Stop and trip</p> <p><b>8-06 Reset Control Word Timeout</b> *[0] No Function [1] Do reset</p> <p><b>8-3* FC Port Settings</b></p> <p><b>8-30 Protocol</b> *[0] FC [2] Modbus</p> <p><b>8-31 Address</b> 1 - 247 * 1</p> <p><b>8-32 FC Port Baud Rate</b> [0] 2400 Baud [1] 4800 Baud *[2] 9600 Baud [3] 19200 Baud *[4] 38400 Baud</p> <p><b>8-33 FC Port Parity</b> *[0] Even Parity, 1 Stop Bit [1] Odd Parity, 1 Stop Bit [2] No Parity, 1 Stop Bit [3] No Parity, 2 Stop Bits</p> <p><b>8-35 Minimum Response Delay</b> 0.001-0.5 * 0.010 s</p> <p><b>8-36 Max Response Delay</b> 0.100 - 10.00 s * 5.000 s</p> <p><b>8-5* Digital/Bus</b></p> <p><b>8-50 Coasting Select</b> [0] DigitalInput [1] Bus [2] LogicAnd *[3] LogicOr</p> <p><b>8-51 Quick Stop Select</b> See par. 8-50 * [3] LogicOr</p> <p><b>8-52 DC Brake Select</b> See par. 8-50 * [3] LogicOr</p> <p><b>8-53 Start Select</b> See par. 8-50 * [3] LogicOr</p> <p><b>8-54 Reversing Select</b> See par. 8-50 * [3] LogicOr</p> <p><b>8-55 Set-up Select</b> See par. 8-50 * [3] LogicOr</p> <p><b>8-56 Preset Reference Select</b> See par. 8-50 * [3] LogicOr</p>
---	--	---	---

<b>13-10 Comparator Operand</b>	[1] NoAction [2] SelectSetup1 [3] SelectSetup2 [10-17] SelectPresetRef0-7 [18] SelectRamp1 [19] SelectRamp2 [22] Run [23] RunReverse [24] Stop [25] Qstop [26] DCstop [27] Coast [28] FreezeOutput [29] StartTimer0 [30] StartTimer1 [31] StartTimer2 [32] Set Digital Output A Low [33] Set Digital Output B Low [38] Set Digital Output A High [39] Set Digital Output B High [60] ResetCounterA [61] ResetCounterB	<b>14-22 Operation Mode</b> *[0] Normal Operation [2] Initialisation <b>14-26 Action At Inverter Fault</b> *[0] Trip [1] Warning <b>14-4 * Energy Optimising</b> <b>14-41 AEO Minimum Magnetisation</b> 40 - 75 % * 66 % <b>15- * * Drive Information</b> <b>15-0 * Operating Data</b> 15-00 Operating Days 15-01 Running Hours 15-02 kWh Counter 15-03 Power Ups 15-04 Over Temps 15-05 Over Volts 15-06 Reset kWh Counter *[0] Do not reset [1] Reset counter 15-07 Reset Running Hours Counter *[0] Do not reset [1] Reset counter <b>15-3 * Fault Log</b> 15-30 Fault Log: Error Code <b>15-4 * Drive Identification</b> 15-40 FC Type 15-41 Power Section 15-42 Voltage 15-43 Software Version 15-46 Frequency Converter Order. No 15-48 LCP Id No 15-51 Frequency Converter Serial No <b>16- * * Data Readouts</b> <b>16-0 * General Status</b> 16-00 Control Word 0 - 0XFFFF 16-01 Reference [Unit] -4999 - 4999 16-02 Reference % -200.0 - 200.0 % 16-03 Status Word 0 - 0XFFFF 16-05 Main Actual Value [%] -200.0 - 200.0 % 16-09 Custom Readout Dep. on par. 0-31, 0-32 and 4-14	<b>16-1 * Motor Status</b> 16-10 Power [kW] 16-11 Power [hp] 16-12 Motor Voltage [V] 16-13 Frequency [Hz] 16-14 Motor Current [A] 16-15 Frequency [%] 16-18 Motor Thermal [%] <b>16-3 * Drive Status</b> 16-30 DC Link Voltage 16-34 Heatsink Temp. 16-35 Inverter Thermal 16-36 Inv. Nom. Current 16-37 Inv. Max. Current 16-38 SL Controller State <b>16-5 * Ref. / Feedb.</b> 16-50 External Reference 16-51 Pulse Reference 16-52 Feedback [Unit] <b>16-6 * Inputs / Outputs</b> 16-60 Digital Input 18,19,27,33 0 - 1111 16-61 Digital Input 29 0 - 1 16-62 Analog Input 53 (volt) 16-63 Analog Input 53 (current) 16-64 Analog Input 60 16-65 Analog Output 42 [mA] 16-68 Pulse Input [Hz] 16-71 Relay Output [bin] 16-72 Counter A 16-73 Counter B <b>16-8 * Fieldbus / FC Port</b> 16-86 FC Port REF 1 0x8000 - 0x7FFF <b>16-9 * Diagnosis Readouts</b> 16-90 Alarm Word 0 - 0XFFFFFFF 16-92 Warning Word 0 - 0XFFFFFFF 16-94 Ext. Status Word 0 - 0XFFFFFFF
<b>13-11 Comparator Operator</b>	[1] NoAction [2] SelectSetup1 [3] SelectSetup2 [10-17] SelectPresetRef0-7 [18] SelectRamp1 [19] SelectRamp2 [22] Run [23] RunReverse [24] Stop [25] Qstop [26] DCstop [27] Coast [28] FreezeOutput [29] StartTimer0 [30] StartTimer1 [31] StartTimer2 [32] Set Digital Output A Low [33] Set Digital Output B Low [38] Set Digital Output A High [39] Set Digital Output B High [60] ResetCounterA [61] ResetCounterB	<b>14-0 * Inverter Switching</b> 14-01 Switching Frequency [0] 2 kHz *[1] 4 kHz [2] 8 kHz [4] 16 kHz 14-03 Overmodulation [0] Off *[1] On <b>14-12 Function at mains imbalance</b> *[0] Trip [1] Warning [2] Disabled <b>14-2 * Trip Reset</b> 14-20 Reset Mode *[0] Manual reset [1-9] AutoReset 1-9 [10] AutoReset 10 [11] AutoReset 15 [12] AutoReset 20 [13] Infinite auto reset 14-21 Automatic Restart Time 0 - 600 s * 10 s	
<b>13-12 Comparator Value</b>	[1] NoAction [2] SelectSetup1 [3] SelectSetup2 [10-17] SelectPresetRef0-7 [18] SelectRamp1 [19] SelectRamp2 [22] Run [23] RunReverse [24] Stop [25] Qstop [26] DCstop [27] Coast [28] FreezeOutput [29] StartTimer0 [30] StartTimer1 [31] StartTimer2 [32] Set Digital Output A Low [33] Set Digital Output B Low [38] Set Digital Output A High [39] Set Digital Output B High [60] ResetCounterA [61] ResetCounterB	<b>14-0 * Inverter Switching</b> 14-01 Switching Frequency [0] 2 kHz *[1] 4 kHz [2] 8 kHz [4] 16 kHz 14-03 Overmodulation [0] Off *[1] On <b>14-12 Function at mains imbalance</b> *[0] Trip [1] Warning [2] Disabled <b>14-2 * Trip Reset</b> 14-20 Reset Mode *[0] Manual reset [1-9] AutoReset 1-9 [10] AutoReset 10 [11] AutoReset 15 [12] AutoReset 20 [13] Infinite auto reset 14-21 Automatic Restart Time 0 - 600 s * 10 s	
<b>13-20 SL Controller Timer</b>	[1] NoAction [2] SelectSetup1 [3] SelectSetup2 [10-17] SelectPresetRef0-7 [18] SelectRamp1 [19] SelectRamp2 [22] Run [23] RunReverse [24] Stop [25] Qstop [26] DCstop [27] Coast [28] FreezeOutput [29] StartTimer0 [30] StartTimer1 [31] StartTimer2 [32] Set Digital Output A Low [33] Set Digital Output B Low [38] Set Digital Output A High [39] Set Digital Output B High [60] ResetCounterA [61] ResetCounterB	<b>14-0 * Inverter Switching</b> 14-01 Switching Frequency [0] 2 kHz *[1] 4 kHz [2] 8 kHz [4] 16 kHz 14-03 Overmodulation [0] Off *[1] On <b>14-12 Function at mains imbalance</b> *[0] Trip [1] Warning [2] Disabled <b>14-2 * Trip Reset</b> 14-20 Reset Mode *[0] Manual reset [1-9] AutoReset 1-9 [10] AutoReset 10 [11] AutoReset 15 [12] AutoReset 20 [13] Infinite auto reset 14-21 Automatic Restart Time 0 - 600 s * 10 s	
<b>13-2 * Timers</b>	[1] NoAction [2] SelectSetup1 [3] SelectSetup2 [10-17] SelectPresetRef0-7 [18] SelectRamp1 [19] SelectRamp2 [22] Run [23] RunReverse [24] Stop [25] Qstop [26] DCstop [27] Coast [28] FreezeOutput [29] StartTimer0 [30] StartTimer1 [31] StartTimer2 [32] Set Digital Output A Low [33] Set Digital Output B Low [38] Set Digital Output A High [39] Set Digital Output B High [60] ResetCounterA [61] ResetCounterB	<b>14-0 * Inverter Switching</b> 14-01 Switching Frequency [0] 2 kHz *[1] 4 kHz [2] 8 kHz [4] 16 kHz 14-03 Overmodulation [0] Off *[1] On <b>14-12 Function at mains imbalance</b> *[0] Trip [1] Warning [2] Disabled <b>14-2 * Trip Reset</b> 14-20 Reset Mode *[0] Manual reset [1-9] AutoReset 1-9 [10] AutoReset 10 [11] AutoReset 15 [12] AutoReset 20 [13] Infinite auto reset 14-21 Automatic Restart Time 0 - 600 s * 10 s	
<b>13-20 SL Controller Timer</b>	[1] NoAction [2] SelectSetup1 [3] SelectSetup2 [10-17] SelectPresetRef0-7 [18] SelectRamp1 [19] SelectRamp2 [22] Run [23] RunReverse [24] Stop [25] Qstop [26] DCstop [27] Coast [28] FreezeOutput [29] StartTimer0 [30] StartTimer1 [31] StartTimer2 [32] Set Digital Output A Low [33] Set Digital Output B Low [38] Set Digital Output A High [39] Set Digital Output B High [60] ResetCounterA [61] ResetCounterB	<b>14-0 * Inverter Switching</b> 14-01 Switching Frequency [0] 2 kHz *[1] 4 kHz [2] 8 kHz [4] 16 kHz 14-03 Overmodulation [0] Off *[1] On <b>14-12 Function at mains imbalance</b> *[0] Trip [1] Warning [2] Disabled <b>14-2 * Trip Reset</b> 14-20 Reset Mode *[0] Manual reset [1-9] AutoReset 1-9 [10] AutoReset 10 [11] AutoReset 15 [12] AutoReset 20 [13] Infinite auto reset 14-21 Automatic Restart Time 0 - 600 s * 10 s	
<b>13-40 Logic Rule Boolean 1</b>	[1] NoAction [2] SelectSetup1 [3] SelectSetup2 [10-17] SelectPresetRef0-7 [18] SelectRamp1 [19] SelectRamp2 [22] Run [23] RunReverse [24] Stop [25] Qstop [26] DCstop [27] Coast [28] FreezeOutput [29] StartTimer0 [30] StartTimer1 [31] StartTimer2 [32] Set Digital Output A Low [33] Set Digital Output B Low [38] Set Digital Output A High [39] Set Digital Output B High [60] ResetCounterA [61] ResetCounterB	<b>14-0 * Inverter Switching</b> 14-01 Switching Frequency [0] 2 kHz *[1] 4 kHz [2] 8 kHz [4] 16 kHz 14-03 Overmodulation [0] Off *[1] On <b>14-12 Function at mains imbalance</b> *[0] Trip [1] Warning [2] Disabled <b>14-2 * Trip Reset</b> 14-20 Reset Mode *[0] Manual reset [1-9] AutoReset 1-9 [10] AutoReset 10 [11] AutoReset 15 [12] AutoReset 20 [13] Infinite auto reset 14-21 Automatic Restart Time 0 - 600 s * 10 s	
<b>13-41 Logic Rule Operator 1</b>	[1] NoAction [2] SelectSetup1 [3] SelectSetup2 [10-17] SelectPresetRef0-7 [18] SelectRamp1 [19] SelectRamp2 [22] Run [23] RunReverse [24] Stop [25] Qstop [26] DCstop [27] Coast [28] FreezeOutput [29] StartTimer0 [30] StartTimer1 [31] StartTimer2 [32] Set Digital Output A Low [33] Set Digital Output B Low [38] Set Digital Output A High [39] Set Digital Output B High [60] ResetCounterA [61] ResetCounterB	<b>14-0 * Inverter Switching</b> 14-01 Switching Frequency [0] 2 kHz *[1] 4 kHz [2] 8 kHz [4] 16 kHz 14-03 Overmodulation [0] Off *[1] On <b>14-12 Function at mains imbalance</b> *[0] Trip [1] Warning [2] Disabled <b>14-2 * Trip Reset</b> 14-20 Reset Mode *[0] Manual reset [1-9] AutoReset 1-9 [10] AutoReset 10 [11] AutoReset 15 [12] AutoReset 20 [13] Infinite auto reset 14-21 Automatic Restart Time 0 - 600 s * 10 s	
<b>13-42 Logic Rule Boolean 2</b>	[1] NoAction [2] SelectSetup1 [3] SelectSetup2 [10-17] SelectPresetRef0-7 [18] SelectRamp1 [19] SelectRamp2 [22] Run [23] RunReverse [24] Stop [25] Qstop [26] DCstop [27] Coast [28] FreezeOutput [29] StartTimer0 [30] StartTimer1 [31] StartTimer2 [32] Set Digital Output A Low [33] Set Digital Output B Low [38] Set Digital Output A High [39] Set Digital Output B High [60] ResetCounterA [61] ResetCounterB	<b>14-0 * Inverter Switching</b> 14-01 Switching Frequency [0] 2 kHz *[1] 4 kHz [2] 8 kHz [4] 16 kHz 14-03 Overmodulation [0] Off *[1] On <b>14-12 Function at mains imbalance</b> *[0] Trip [1] Warning [2] Disabled <b>14-2 * Trip Reset</b> 14-20 Reset Mode *[0] Manual reset [1-9] AutoReset 1-9 [10] AutoReset 10 [11] AutoReset 15 [12] AutoReset 20 [13] Infinite auto reset 14-21 Automatic Restart Time 0 - 600 s * 10 s	
<b>13-43 Logic Rule Operator 2</b>	[1] NoAction [2] SelectSetup1 [3] SelectSetup2 [10-17] SelectPresetRef0-7 [18] SelectRamp1 [19] SelectRamp2 [22] Run [23] RunReverse [24] Stop [25] Qstop [26] DCstop [27] Coast [28] FreezeOutput [29] StartTimer0 [30] StartTimer1 [31] StartTimer2 [32] Set Digital Output A Low [33] Set Digital Output B Low [38] Set Digital Output A High [39] Set Digital Output B High [60] ResetCounterA [61] ResetCounterB	<b>14-0 * Inverter Switching</b> 14-01 Switching Frequency [0] 2 kHz *[1] 4 kHz [2] 8 kHz [4] 16 kHz 14-03 Overmodulation [0] Off *[1] On <b>14-12 Function at mains imbalance</b> *[0] Trip [1] Warning [2] Disabled <b>14-2 * Trip Reset</b> 14-20 Reset Mode *[0] Manual reset [1-9] AutoReset 1-9 [10] AutoReset 10 [11] AutoReset 15 [12] AutoReset 20 [13] Infinite auto reset 14-21 Automatic Restart Time 0 - 600 s * 10 s	
<b>13-44 Logic Rule Boolean 3</b>	[1] NoAction [2] SelectSetup1 [3] SelectSetup2 [10-17] SelectPresetRef0-7 [18] SelectRamp1 [19] SelectRamp2 [22] Run [23] RunReverse [24] Stop [25] Qstop [26] DCstop [27] Coast [28] FreezeOutput [29] StartTimer0 [30] StartTimer1 [31] StartTimer2 [32] Set Digital Output A Low [33] Set Digital Output B Low [38] Set Digital Output A High [39] Set Digital Output B High [60] ResetCounterA [61] ResetCounterB	<b>14-0 * Inverter Switching</b> 14-01 Switching Frequency [0] 2 kHz *[1] 4 kHz [2] 8 kHz [4] 16 kHz 14-03 Overmodulation [0] Off *[1] On <b>14-12 Function at mains imbalance</b> *[0] Trip [1] Warning [2] Disabled <b>14-2 * Trip Reset</b> 14-20 Reset Mode *[0] Manual reset [1-9] AutoReset 1-9 [10] AutoReset 10 [11] AutoReset 15 [12] AutoReset 20 [13] Infinite auto reset 14-21 Automatic Restart Time 0 - 600 s * 10 s	
<b>13-51 SL Controller Event</b>	[1] NoAction [2] SelectSetup1 [3] SelectSetup2 [10-17] SelectPresetRef0-7 [18] SelectRamp1 [19] SelectRamp2 [22] Run [23] RunReverse [24] Stop [25] Qstop [26] DCstop [27] Coast [28] FreezeOutput [29] StartTimer0 [30] StartTimer1 [31] StartTimer2 [32] Set Digital Output A Low [33] Set Digital Output B Low [38] Set Digital Output A High [39] Set Digital Output B High [60] ResetCounterA [61] ResetCounterB	<b>14-0 * Inverter Switching</b> 14-01 Switching Frequency [0] 2 kHz *[1] 4 kHz [2] 8 kHz [4] 16 kHz 14-03 Overmodulation [0] Off *[1] On <b>14-12 Function at mains imbalance</b> *[0] Trip [1] Warning [2] Disabled <b>14-2 * Trip Reset</b> 14-20 Reset Mode *[0] Manual reset [1-9] AutoReset 1-9 [10] AutoReset 10 [11] AutoReset 15 [12] AutoReset 20 [13] Infinite auto reset 14-21 Automatic Restart Time 0 - 600 s * 10 s	
<b>13-52 SL Controller Action</b>	[1] NoAction [2] SelectSetup1 [3] SelectSetup2 [10-17] SelectPresetRef0-7 [18] SelectRamp1 [19] SelectRamp2 [22] Run [23] RunReverse [24] Stop [25] Qstop [26] DCstop [27] Coast [28] FreezeOutput [29] StartTimer0 [30] StartTimer1 [31] StartTimer2 [32] Set Digital Output A Low [33] Set Digital Output B Low [38] Set Digital Output A High [39] Set Digital Output B High [60] ResetCounterA [61] ResetCounterB	<b>14-0 * Inverter Switching</b> 14-01 Switching Frequency [0] 2 kHz *[1] 4 kHz [2] 8 kHz [4] 16 kHz 14-03 Overmodulation [0] Off *[1] On <b>14-12 Function at mains imbalance</b> *[0] Trip [1] Warning [2] Disabled <b>14-2 * Trip Reset</b> 14-20 Reset Mode *[0] Manual reset [1-9] AutoReset 1-9 [10] AutoReset 10 [11] AutoReset 15 [12] AutoReset 20 [13] Infinite auto reset 14-21 Automatic Restart Time 0 - 600 s * 10 s	

### 6.2.1 Conversion Index

The various attributes of each parameter are displayed in the section *Factory Settings*. Parameter values are transferred as whole numbers only. Conversion factors are therefore used to transfer decimals according to the table below.

Example:

Par. 1-24 *Motor Current* has a conversion index of -2 (i.e. conversion factor of 0.01 according to the table below). To set the parameter to 2.25 A, transfer the value 225 via Modbus. The Conversion Factor of 0.01 means that the value transferred is multiplied by 0.01 in the drive. The value 225 transferred on the bus is thus perceived as 2.25 A in the drive.

Conversion index	Conversion factor
2	10
1	100
0	1
-1	0.1
-2	0.01
-3	0.001
-4	0.0001
-5	0.00001

Table 6.1: Conversion table



### 6.2.2 Change during operation

“TRUE” means that the parameter can be changed while the frequency converter is in operation and “FALSE” means that the frequency converter must be stopped before a change can be made.

### 6.2.3 2-Set-up

“All set-up”: The parameter can be set individually in each of the two set-ups, i.e. one single parameter can have two different data values.

“1 set-up”: Data value will be the same in both set-ups.

### 6.2.4 Type

Data Type	Description	Type
2	Integer 8	Int8
3	Integer 16	Int16
4	Integer 32	Int32
5	Unsigned 8	UInt8
6	Unsigned 16	UInt16
7	Unsigned 32	UInt32
9	Visible string	VisibleString

## 6.2.5 0- \* \* Operation/Display

Parameter Number	Parameter Description	Default Value	2 Setup	Change During Operation	Conversion Index	Type
0 - 03	Regional Settings	[0] International	1 set-up	FALSE	-	Uint8
0 - 04	Operating State at Power-up (Hand)	[1] Forced stop ref=old	All set-ups	TRUE	-	Uint8
0 - 10	Active Set-up	[1] Set-up 1	1 set-up	TRUE	-	Uint8
0 - 11	Edit Set-up	[1] Set-up 1	1 set-up	TRUE	-	Uint8
0 - 12	Link Setups	[20] Linked	All set-ups	FALSE	-	Uint8
0 - 40	[Hand on] Key on LCP	[1] Enabled	All set-ups	TRUE	-	Uint8
0 - 41	[Off / Reset] Key on LCP	[1] Enable All	All set-ups	TRUE	-	Uint8
0 - 42	[Auto on] Key on LCP	[1] Enabled	All set-ups	TRUE	-	Uint8
0 - 50	LCP Copy	[0] No copy	1 set-up	FALSE	-	Uint8
0 - 51	Set-up Copy	[0] No copy	1 set-up	FALSE	-	Uint8
0 - 60	Main Menu Password	0	1 set-up	TRUE	0	Uint16

**6.2.6 1-\*\* Load/Motor**

Parameter Number	Parameter Description	Default Value	2 Setup	Change During Operation	Conversion Index	Type
1-00	Configuration Mode	[0] Speed open loop	All set-ups	TRUE	-	Uint8
1-01	Motor Control Principle	[1] VVC+	All set-ups	FALSE	-	Uint8
1-03	Torque Characteristics	[0] Constant torque	All set-ups	TRUE	-	Uint8
1-05	Hand Mode Configuration	[2] As mode par 1-00	All set-ups	TRUE	-	Uint8
1-20	Motor Power		All set-ups	FALSE	-	Uint8
1-22	Motor Voltage		All set-ups	FALSE	0	Uint16
1-23	Motor Frequency		All set-ups	FALSE	0	Uint16
1-24	Motor Current		All set-ups	FALSE	-2	Uint16
1-25	Motor Nominal Speed		All set-ups	FALSE	0	Uint16
1-29	Automatic Motor Tuning (AMT)	[0] Off	1 set-up	FALSE	-	Uint8
1-30	Stator Resistance (Rs)		All set-ups	FALSE	-2	Uint16
1-33	Stator Leakage Reactance (X1)		All set-ups	FALSE	-2	Uint32
1-35	Main Reactance (Xh)		All set-ups	FALSE	-2	Uint16
1-50	Motor Magnetisation at Zero Speed	100%	All set-ups	TRUE	0	Uint16
1-52	Min Speed Normal Magnetising [Hz]	0 Hz	All set-ups	TRUE	-1	Uint16
1-55	U/f Characteristic - U		All set-ups	TRUE	0	Uint16
1-56	U/f Characteristic - F		All set-ups	TRUE	0	Uint16
1-60	Low Speed Load Compensation	100%	All set-ups	TRUE	0	Uint16
1-61	High Speed Load Compensation	100%	All set-ups	TRUE	0	Uint16
1-62	Slip Compensation	100%	All set-ups	TRUE	0	Uint16
1-63	Slip Compensation Time Constant	0.1 s	All set-ups	TRUE	-2	Uint16
1-71	Start Delay	0 s	All set-ups	TRUE	-1	Uint8
1-72	Start Function	[2] Coast/delay time	All set-ups	TRUE	-	Uint8
1-73	Flying Start	[0] Disabled	All set-ups	FALSE	-	Uint8
1-80	Function at Stop	[0] Coast	All set-ups	TRUE	-	Uint8
1-82	Min Speed for Function at Stop [Hz]	0 Hz	All set-ups	TRUE	-1	Uint16
1-90	Motor Thermal Protection	[0] No protection	All set-ups	TRUE	-	Uint8
1-93	Thermistor Resource	[0] None	All set-ups	FALSE	-	Uint8

### 6.2.7 2- \* \* Brakes

Parameter Number	Parameter Description	Default Value	2 Setup	Change During Operation	Conversion Index	Type
2 - 00	DC Hold Current	50%	All set-ups	TRUE	0	Uint16
2 - 01	DC Brake Current	50%	All set-ups	TRUE	0	Uint16
2 - 02	DC Braking Time	10 s	All set-ups	TRUE	-1	Uint16
2 - 04	DC Brake Cut In Speed	0 Hz	All set-ups	TRUE	-1	Uint16
2 - 10	Brake Function	[0] Off	All set-ups	TRUE	-	Uint8
2 - 11	Brake Resistor (ohm)	100%	All set-ups	TRUE	0	Uint16
2 - 16	AC Brake, Max current	[0] Disabled	All set-ups	TRUE	0	Uint16
2 - 17	Over-voltage Control	0 A	All set-ups	TRUE	-	Uint8
2 - 20	Release Brake Current	0 Hz	All set-ups	TRUE	-2	Uint32
2 - 22	Activate Brake Speed [Hz]	0 Hz	All set-ups	TRUE	-1	Uint16



**6.2.8 3-\*\*-Reference/Ramps**

Parameter Number	Parameter Description	Default Value	2 Setup	Change During Operation	Conversion Index	Type
3-00	Reference Range	[0] Min - Max	All set-ups	TRUE	-	Uint8
3-02	Minimum Reference	0	All set-ups	TRUE	-3	Int32
3-03	Maximum Reference	50	All set-ups	TRUE	-3	Int32
3-10	Preset Reference	0%	All set-ups	TRUE	-2	Int16
3-11	Jog Speed [Hz]	5 Hz	All set-ups	TRUE	-1	Uint16
3-12	Catch up/slow Down Value	0%	All set-ups	TRUE	-2	Int16
3-14	Preset Relative Reference	0%	All set-ups	TRUE	-2	Int16
3-15	Reference Resource 1	[1] Analog in 53	All set-ups	TRUE	-	Uint8
3-16	Reference Resource 2	[2] Analog in 60	All set-ups	TRUE	-	Uint8
3-17	Reference Resource 3	[11] Local bus reference	All set-ups	TRUE	-	Uint8
3-18	Relative Scaling Reference Resource	[0] No function	All set-ups	TRUE	-	Uint8
3-40	Ramp 1 Type	[0] Linear	All set-ups	TRUE	-	Uint8
3-41	Ramp 1 Ramp up Time	3 s	All set-ups	TRUE	-2	Uint32
3-42	Ramp 1 Ramp Down Time	3 s	All set-ups	TRUE	-2	Uint32
3-50	Ramp 2 Type	[0] Linear	All set-ups	TRUE	-	Uint8
3-51	Ramp 2 Ramp up Time	3 s	All set-ups	TRUE	-2	Uint32
3-52	Ramp 2 Ramp down Time	3 s	All set-ups	TRUE	-2	Uint32
3-80	Jog Ramp Time	3 s	All set-ups	TRUE	-2	Uint32
3-81	Quick Stop Ramp Time	3 s	1 set-up	TRUE	-2	Uint32

### 6.2.9 4- \* \* Limits/Warnings

Parameter Number	Parameter Description	Default Value	2 Setup	Change During Operation	Conversion Index	Type
4 - 10	Motor Speed Direction	[2] Both directions	All set-ups	FALSE	-	Uint8
4 - 12	Motor Speed Low Limit [Hz]	0 Hz	All set-ups	FALSE	-1	Uint16
4 - 14	Motor Speed High Limit [Hz]	65 Hz	All set-ups	FALSE	-1	Uint16
4 - 16	Torque Limit Motor Mode	150%	All set-ups	TRUE	0	Uint16
4 - 17	Torque Limit Generator Mode	100%	All set-ups	TRUE	0	Uint16
4 - 50	Warning Current Low	0 A	All set-ups	TRUE	-2	Uint32
4 - 51	Warning Current High	26 A	All set-ups	TRUE	-2	Uint32
4 - 58	Missing Motor Phase Function	[1] On	All set-ups	FALSE	-	Uint8
4 - 61	Bypass Speed From [Hz]	0 Hz	All set-ups	TRUE	-1	Uint16
4 - 63	Bypass Speed To [Hz]	0 Hz	All set-ups	TRUE	-1	Uint16

**6.2.10 5-\*\*-Digital In/Out**

Parameter Number	Parameter Description	Default Value	2 Setup	Change During Operation	Conversion Index	Type
5 - 10	Terminal 18 Digital Input	[8] Start	All set-ups	TRUE	-	UInt8
5 - 11	Terminal 19 Digital Input	[10] Reversing	All set-ups	TRUE	-	UInt8
5 - 12	Terminal 27 Digital Input	[1] Reset	All set-ups	TRUE	-	UInt8
5 - 13	Terminal 29 Digital Input	[14] Jog	All set-ups	TRUE	-	UInt8
5 - 15	Terminal 33 Digital Input	[16] Preset ref bit 0	All set-ups	TRUE	-	UInt8
5 - 40	Function Relay	[0] No operation	All set-ups	TRUE	-	UInt8
5 - 55	Terminal 33 Low Frequency	20 Hz	All set-ups	TRUE	0	UInt16
5 - 56	Terminal 33 High Frequency	5000 Hz	All set-ups	TRUE	0	UInt16
5 - 57	Terminal 33 Low Ref./Feedb. Value	0	All set-ups	TRUE	-3	Int32
5 - 58	Terminal 33 High Ref./Feedb. Value	50	All set-ups	TRUE	-3	Int32

## 6.2.11 6- \* \* Analog In/Out

Parameter Number	Parameter Description	Default Value	2 Setup	Change During Operation	Conversion Index	Type
6 - 00	Live Zero Timeout Time	10 s	All set-ups	TRUE	0	Uint8
6 - 01	Live Zero TimeoutFunction	[0] Off	All set-ups	TRUE	-	Uint8
6 - 10	Terminal 53 Low Voltage	0,07 V	All set-ups	TRUE	-2	Uint16
6 - 11	Terminal 53 High Voltage	10 V	All set-ups	TRUE	-2	Uint16
6 - 12	Terminal 53 Low Current	0,14 mA	All set-ups	TRUE	-2	Uint16
6 - 13	Terminal 53 High Current	20 mA	All set-ups	TRUE	-2	Uint16
6 - 14	Terminal 53 Low Ref./Feedb. Value	0	All set-ups	TRUE	-3	Int32
6 - 15	Terminal 53 High Ref./Feedb. Value	50	All set-ups	TRUE	-3	Int32
6 - 16	Terminal 53 Filter Time Constant	0,01 s	All set-ups	TRUE	-2	Uint16
6 - 19	Terminal 53 mode	[0] Voltage mode	1 set-up	TRUE	-	Uint8
6 - 22	Terminal 60 Low Current	0,14 mA	All set-ups	TRUE	-2	Uint16
6 - 23	Terminal 60 High Current	20 mA	All set-ups	TRUE	-2	Uint16
6 - 24	Terminal 60 Low Ref./Feedb. Value	0	All set-ups	TRUE	-3	Int32
6 - 25	Terminal 60 High Ref./Feedb. Value	50	All set-ups	TRUE	-3	Int32
6 - 26	Terminal 60 Filter Time Constant	0,01 s	All set-ups	TRUE	-2	Uint16
6 - 81	LCP potentiometer Low Ref.	0	All set-ups	TRUE	-3	Int32
6 - 82	LCP potentiometer High Ref.	50	All set-ups	TRUE	-3	Int32
6 - 90	Terminal 42 Mode	[0] 0-20 mA	All set-ups	TRUE	-	Uint8
6 - 91	Terminal 42 Analog Output	[0] No operation	All set-ups	TRUE	-	Uint8
6 - 92	Terminal 42 Digital Output	[0] No operation	All set-ups	TRUE	-	Uint8
6 - 93	Terminal 42 Output Min Scale	0%	All set-ups	TRUE	-2	Uint16
6 - 94	Terminal 42 Output Max Scale	100%	All set-ups	TRUE	-2	Uint16

**6.2.12 7- \*\* Controllers**

Parameter Number	Parameter Description	Default Value	2 Setup	Change During Operation	Conversion Index	Type
7 - 20	Process CL Feedback 1 Resource	[0] No function	All set-ups	TRUE	-	Uint8
7 - 30	Process PI Normal/ Inverse Control	[0] Normal	All set-ups	TRUE	-	Uint8
7 - 31	Process PI Anti Windup	[1] Enabled	All set-ups	TRUE	-	Uint8
7 - 32	Process PI Start Speed	0 Hz	All set-ups	TRUE	-1	Uint16
7 - 33	Process PI Proportional Gain	0.01	All set-ups	TRUE	-2	Uint16
7 - 34	Process PI Integral Time	9999 s	All set-ups	TRUE	-2	Uint32
7 - 38	Process PI Feed Forward Factor	0%	All set-ups	TRUE	0	Uint16
7 - 39	On Reference Bandwidth	5%	All set-ups	TRUE	0	Uint8

## 6.2.13 8- \* \* Comm. and Options

Parameter Number	Parameter Description	Default Value	2 Setup	Change During Operation	Conversion Index	Type
8 - 01	Control Site	[0] Digital and ctrl.word	All set-ups	TRUE	-	Uint8
8 - 02	Control Word Source	[1] FC RS485	All set-ups	TRUE	-	Uint8
8 - 03	Control Word Timeout Time	1 s	1 set-up	TRUE	-1	Uint16
8 - 04	Control Word Timeout Function	[0] Off	1 set-up	TRUE	-	Uint8
8 - 06	Reset Control Word Timeout	[0] No function	1 set-up	TRUE	-	Uint8
8 - 30	Protocol	[0] FC	1 set-up	TRUE	0	Uint8
8 - 31	Address	1	1 set-up	TRUE	0	Uint8
8 - 32	FC Port Baud Rate	[2] 9600 Baud	1 set-up	TRUE	-	Uint8
8 - 33	FC Port Parity	[0] Even Parity 1 Stop Bit	1 set-up	TRUE	-	Uint8
8 - 35	Minimum Response Delay	0.01 s	1 set-up	TRUE	-3	Uint16
8 - 36	Max Response Delay	5 s	1 set-up	TRUE	-3	Uint16
8 - 50	Coasting Select	[3] Logic OR	All set-ups	TRUE	-	Uint8
8 - 51	Quick Stop Select	[3] Logic OR	All set-ups	TRUE	-	Uint8
8 - 52	DC Brake Select	[3] Logic OR	All set-ups	TRUE	-	Uint8
8 - 53	Start Select	[3] Logic OR	All set-ups	TRUE	-	Uint8
8 - 54	Reversing Select	[3] Logic OR	All set-ups	TRUE	-	Uint8
8 - 55	Set-up Select	[3] Logic OR	All set-ups	TRUE	-	Uint8
8 - 56	Preset Reference Select	[3] Logic OR	All set-ups	TRUE	-	Uint8
8 - 94	Bus feedback 1	0	All set-ups	TRUE	0	Int16

Parameter Number	SmartLogic Description	Default Value	2 Setup	Change During Operation	Conversion Index	Type
13 - 00	SL Controller Mode	[0] Off	1 set-up	TRUE	-	Uint8
13 - 01	Start Event	[39] Start command	1 set-up	TRUE	-	Uint8
13 - 02	Stop Event	[40] Drive stopped	1 set-up	TRUE	-	Uint8
13 - 03	Reset SLC	[0] Do not reset	1 set-up	TRUE	-	Uint8
13 - 10	Comparator Operand	[0] Disabled	1 set-up	TRUE	-	Uint8
13 - 11	Comparator Operator	[1] ApproxEqual	1 set-up	TRUE	-	Uint8
13 - 12	Comparator Value	0	1 set-up	TRUE	-1	Int32
13 - 20	SL Controller Timer	0 s	1 set-up	TRUE	-1	Uint32
13 - 40	Logic Rule Boolean 1	[0] False	1 set-up	TRUE	-	Uint8
13 - 41	Logic Rule Operator 1	[0] Disabled	1 set-up	TRUE	-	Uint8
13 - 42	Logic Rule Boolean 2	[0] False	1 set-up	TRUE	-	Uint8
13 - 43	Logic Rule Operator 2	[0] Disabled	1 set-up	TRUE	-	Uint8
13 - 44	Logic Rule Boolean 3	[0] False	1 set-up	TRUE	-	Uint8
13 - 51	SL Controller Event	[0] False	1 set-up	TRUE	-	Uint8
13 - 52	SL Controller Action	[0] Disabled	1 set-up	TRUE	-	Uint8

### 6.2.15 14-.\* Special Functions

Parameter Number	Parameter Description	Default Value	2 Setup	Change During Operation	Conversion Index	Type
14 - 01	Switching Frequency	[1] 4.0 kHz	All set-ups	TRUE	-	Uint8
14 - 03	Overmodulation	[1] On	All set-ups	FALSE	-	Uint8
14 - 12	Function at Mains Imbalance	[0] Trip	All set-ups	TRUE	-	Uint8
14 - 20	Reset Mode	[0] Manual reset	All set-ups	TRUE	-	Uint8
14 - 21	Automatic Restart Time	10 s	All set-ups	TRUE	0	Uint16
14 - 22	Operation Mode	[0] Normal operation	1 set-up	TRUE	-	Uint8
14 - 26	Action At Inverter Fault	[0] Trip	All set-ups	TRUE	-	Uint8
14 - 41	AEO Minimum Magnetisation	66 %	All set-ups	TRUE	0	Uint8



**6.2.16 15- \*\* Drive Information**

Parameter Number	Parameter Description	Default Value	2 Setup	Change During Operation	Conversion Index	Type
15 - 00	Operating Time	0	1 set-up	TRUE	0	Uint32
15 - 01	Running Hours	0	1 set-up	TRUE	0	Uint32
15 - 02	kWh Counter	0	1 set-up	TRUE	0	Uint32
15 - 03	Power Up's	0	1 set-up	TRUE	0	Uint32
15 - 04	Over Temp's	0	1 set-up	TRUE	0	Uint16
15 - 05	Over Volt's	0	1 set-up	TRUE	0	Uint16
15 - 06	Reset kWh Counter	[0] Do not reset	1 set-up	TRUE	-	Uint8
15 - 07	Reset Running Hours Counter	[0] Do not reset	1 set-up	TRUE	-	Uint8
15 - 30	Fault Log: Error Code	0	1 set-up	TRUE	0	Uint8
15 - 40	FC Type		1 set-up	FALSE	0	VisibleString
15 - 41	Power Section		1 set-up	FALSE	0	VisibleString
15 - 42	Voltage		1 set-up	FALSE	0	VisibleString
15 - 43	SW ID Control Card		1 set-up	FALSE	0	VisibleString
15 - 46	Frequency Converter Ordering No		1 set-up	FALSE	0	VisibleString
15 - 48	LCP Id No		1 set-up	FALSE	0	VisibleString
15 - 51	Frequency Converter Serial Number		1 set-up	FALSE	0	VisibleString

## 6.2.17 16- \* \* Data Readouts

Parameter Number	Parameter Description	Default Value	2 Setup	Change During Operation	Conversion Index	Type
16 - 00	Control Word	0	1 set-up	TRUE	0	Uint16
16 - 01	Reference [Unit]	0	1 set-up	TRUE	-3	Int32
16 - 02	Reference %	0	1 set-up	TRUE	-1	Int16
16 - 03	Status Word	0	1 set-up	TRUE	0	Uint16
16 - 05	Main Actual Value [%]	0	1 set-up	TRUE	-2	Int16
16 - 10	Power [kW]	0	1 set-up	TRUE	-3	Uint16
16 - 11	Power [hp]	0	1 set-up	TRUE	-3	Uint16
16 - 12	Motor Voltage	0	1 set-up	TRUE	0	Uint16
16 - 13	Frequency	0	1 set-up	TRUE	-1	Uint16
16 - 14	Motor Current	0	1 set-up	TRUE	-2	Uint16
16 - 15	Frequency [%]	0	1 set-up	TRUE	-1	Uint16
16 - 18	Motor Thermal	0	1 set-up	TRUE	0	Uint8
16 - 30	DC Link Voltage	0	1 set-up	TRUE	0	Uint16
16 - 34	Heatsink Temp.	0	1 set-up	TRUE	0	Uint8
16 - 35	Inverter Thermal	0	1 set-up	TRUE	0	Uint8
16 - 36	Inv. Nom. Current	0	1 set-up	TRUE	-2	Uint16
16 - 37	Inv. Max. Current	0	1 set-up	TRUE	-2	Uint16
16 - 38	SL Controller State	0	1 set-up	TRUE	0	Uint8
16 - 50	External Reference	0	1 set-up	TRUE	-1	Int16
16 - 51	Pulse Reference	0	1 set-up	TRUE	-1	Int16
16 - 52	Feedback [Unit]	0	1 set-up	TRUE	-3	Int32
16 - 60	Digital input 18,19,27,33	0	1 set-up	TRUE	0	Uint16
16 - 61	Digital input 29	0	1 set-up	TRUE	0	Uint16
16 - 62	Analog Input 53 (V)	0	1 set-up	TRUE	-2	Uint16
16 - 63	Analog Input 53 (mA)	0	1 set-up	TRUE	-2	Uint16
16 - 64	Analog Input 60	0	1 set-up	TRUE	-2	Uint16
16 - 65	Analog Output 42 [mA]	0	1 set-up	TRUE	-2	Uint16
16 - 68	Pulse input 33	20	1 set-up	TRUE	0	Uint16
16 - 71	Relay Output [bin]	0	1 set-up	TRUE	0	Uint8
16 - 72	Counter A	0	1 set-up	TRUE	0	Int16
16 - 73	Counter B	0	1 set-up	TRUE	0	Int16
16 - 86	FC Port REF 1	0	1 set-up	TRUE	0	Int16
16 - 90	Alarm Word	0	1 set-up	TRUE	0	Uint32
16 - 92	Warning Word	0	1 set-up	TRUE	0	Uint32
16 - 94	Ext. Status Word	0	1 set-up	TRUE	0	Uint32

# 7 Troubleshooting

No.	Description	Warning	Alarm	Trip Lock	Error	Cause of Problem
2	Live zero error	X	X			Signal on terminal 53 or 60 is less than 50% of value set in par. 6-10, 6-12 and 6-22.
4	Mains phase loss <sup>1)</sup>	X	X	X		Missing phase on supply side, or too high voltage imbalance. Check supply voltage.
7	DC over voltage <sup>1)</sup>	X	X			Intermediate circuit voltage exceeds limit.
8	DC under voltage <sup>1)</sup>	X	X			Intermediate circuit voltage drops below "voltage warning low" limit.
9	Inverter overloaded	X	X			More than 100% load for too long.
10	Motor ETR over temperature	X	X			Motor is too hot due to more than 100% load for too long.
11	Motor thermistor over temperature	X	X			Thermistor or thermistor connection is disconnected.
12	Torque limit	X				Torque exceeds value set in either par. 4-16 or 4-17.
13	Over Current	X	X	X		Inverter peak current limit is exceeded.
14	Earth fault		X	X		Discharge from output phases to ground.
16	Short Circuit		X	X		Short-circuit in motor or on motor terminals.
17	Control word timeout	X	X			No communication to frequency converter.
25	Brake resistor short-circuited		X	X		Brake resistor is short-circuited, thus brake function is disconnected.
27	Brake chopper short-circuited		X	X		Brake transistor is short-circuited, thus brake function is disconnected.
28	Brake check		X			Brake resistor is not connected/working
29	Power board over temp	X	X	X		Heat-sink cut-out temperature has been reached.
30	Motor phase U missing		X	X		Motor phase U is missing. Check the phase.
31	Motor phase V missing		X	X		Motor phase V is missing. Check the phase.
32	Motor phase W missing		X	X		Motor phase W is missing. Check the phase.
38	Internal fault		X	X		Contact local Danfoss supplier.
47	Control Voltage Fault	X	X	X		24 V DC may be overloaded.
51	AMT check $I_{nom}$ and $I_{nom}$		X			Wrong setting for motor voltage and/or motor current.
52	AMT low $I_{nom}$		X			Motor current is too low. Check settings.
59	Current limit	X				VLT overload.
63	Mechanical Brake Low		X			Actual motor current has not exceeded "release brake" current within "start delay" time window.
80	Drive Initialised to Default Value		X			All parameter settings are initialized to default settings.
84	The connection between drive and LCP is lost				X	No communication between LCP and frequency converter
85	Button disabled				X	See parameter group 0-4* LCP
86	Copy fail				X	An error occurred while copying from frequency converter to LCP or vice versa.
87	LCP data invalid				X	Occurs when copying from LCP if the LCP contains erroneous data - or if no data was uploaded to the LCP.
88	LCP data not compatible				X	Occurs when copying from LCP if data are moved between frequency converters with major differences in software versions.
89	Parameter read only				X	Occurs when trying to write to a read-only parameter.
90	Parameter database busy				X	LCP and RS485 connection are trying to update parameters simultaneously.
91	Parameter value is not valid in this mode				X	Occurs when trying to write an illegal value to a parameter.
92	Parameter value exceeds the min/max limits				X	Occurs when trying to set a value outside the range.
nw run	Not While RUNNING				X	Parameter can only be changed when the motor is stopped.
Err.	A wrong password was entered				X	Occurs when using a wrong password for changing a password-protected parameter.

<sup>1)</sup> These faults may be caused by mains distortions. Installing Danfoss Line Filter may rectify this problem.

Table 7.1: Warnings and Alarms Code list

### 7.1.1 Alarm, Warning and Extended Status Word

Bit	Hex	Dec	Par 1690	Par 1692	Par 1694
			AlarmWord	WarningWord	ExtendedStatusWord
0	1	1	Brake check		Ramping
1	2	2	Pwr.card temp	Pwr.card temp	
2	4	4	Earth Fault		Start CW/CCW
3	8	8			Slow down
4	10	16	Ctrl.word TO	Ctrl.word TO	Catch up
5	20	32	Over Current	Over Current	
6	40	64		Torque limit	
7	80	128	Motor th over	Motor th over	Output current high
8	100	256	Motor ETR over	Motor ETR over	Output current low
9	200	512	Inverter overload	Inverter overload	
10	400	1024	DC under volt	DC under volt	
11	800	2048	DC over volt	DC over volt	
12	1000	4096	Short Circuit		
13	2000	8192			Braking
14	4000	16384	Mains ph. loss	Mains ph. loss	
15	8000	32768	"AMT Not OK"		OVC active
16	10000	65536	Live zero error	Live zero error	AC brake
17	20000	131072	Internal fault		
18	40000	262144			
19	80000	524288	U phase loss		
20	100000	1048576	V phase loss		
21	200000	2097152	W phase loss		
22	400000	4194304			
23	800000	8388608	Control Voltage Fault		
24	1000000	16777216			
25	2000000	33554432		Current limit	
26	4000000	67108864	Brake resistor shortcircuit		
27	8000000	134217728	Brake IGBT shortcircuit		
28	10000000	268435456		MotorPhaseMissing	
29	20000000	536870912	Drive initialised		
30	40000000	1073741824		Undefined	
31	80000000	2147483648	Mech. brake low		DatabaseBusy

# 8 Specifications

## 8.1 Mains Supply

### 8.1.1 Mains Supply 1 x 200 - 240 VAC

Normal overload 150% for 1 minute						
	Frame M1	Frame M1	Frame M1	Frame M2	Frame M3	
Frequency converter	P0K18	P0K37	P0K75	P1K5	P2K2	
Typical Shaft Output [kW]	0.18	0.37	0.75	1.5	2.2	
	Typical Shaft Output [HP]					
	0.25	0.5	1	2	3	
Output current						
	Continuous (3 x 200-240 V) [A]	1.2	2.2	4.2	6.8	9.6
	Intermittent (3 x 200-240 V) [A]	1.8	3.3	6.3	10.2	14.4
	Max. cable size:					
	(mains, motor) [mm <sup>2</sup> /AWG]	4/10				
Max. input current						
	Continuous (1 x 200-240 V) [A]	3.3	6.1	11.6	18.7	26.4
	Intermittent (1 x 200-240 V) [A]	4.5	8.3	15.6	26.4	37.0
	Max. pre-fuses [A]	See Section <i>Fuses</i>				
	Environment					
	Estimated power loss at rated load [W],	12.5/	20.0/	36.5/	61.0/	81.0/85.1
	Best case/Typical <sup>1)</sup>	15.5	25.0	44.0	67.0	
Weight enclosure IP20 [kg]	1.1	1.1	1.1	1.6	3.0	
Efficiency	95.6/	96.5/	96.6/	97.0/	96.9/97.1	
Best case/Typical <sup>1)</sup>	94.5	95.6	96.0	96.7		

Table 8.1: Mains supply 1 x 200 - 240 VAC

### 8.1.2 Mains Supply 3 x 200 - 240 VAC

Normal overload 150% for 1 minute							
	Frame M1	Frame M1	Frame M1	Frame M2	Frame M3	Frame M3	
Frequency converter	P0K25	P0K37	P0K75	P1K5	P2K2	P3K7	
Typical Shaft Output [kW]	0.25	0.37	0.75	1.5	2.2	3.7	
	Typical Shaft Output [HP]						
	0.33	0.5	1	2	3	5	
Output current							
	Continuous (3 x 200-240 V) [A]	1.5	2.2	4.2	6.8	9.6	
	Intermittent (3 x 200-240 V) [A]	2.3	3.3	6.3	10.2	14.4	
	Max. cable size:						
	(mains, motor) [mm <sup>2</sup> /AWG]	4/10					
Max. input current							
	Continuous (3 x 200-240 V) [A]	2.4	3.5	6.7	10.9	15.4	
	Intermittent (3 x 200-240 V) [A]	3.2	4.6	8.3	14.4	23.4	
	Max. pre-fuses [A]	See Section <i>Fuses</i>					
	Environment						
	Estimated power loss at rated load [W],	14.0/	19.0/	31.5/	51.0/	72.0/	115.0/
	Best case/Typical <sup>1)</sup>	20.0	24.0	39.5	57.0	77.1	122.8
Weight enclosure IP20 [kg]	1.1	1.1	1.1	1.6	3.0	3.0	
Efficiency	96.4/	96.7/	97.1/	97.4/	97.2/	97.3/	
Best case/Typical <sup>1)</sup>	94.9	95.8	96.3	97.2	97.4	97.4	

Table 8.1: Mains supply 3 x 200 - 240 VAC

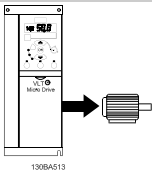
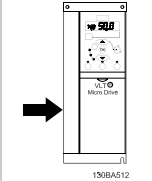
1. Power loss at rated load conditions.

### 8.1.3 Mains Supply 3 x 380 - 480 VAC

Normal overload 150% for 1 minute

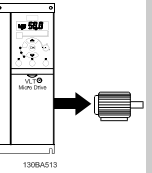
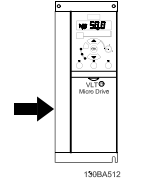
Frequency converter

Typical Shaft Output [kW]

Typical Shaft Output [HP]

IP 20

Output current

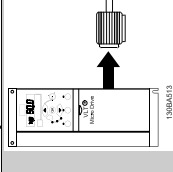

	P0K37	P0K75	P1K5	P2K2	P3K0	P4K0	P5K5	P7K5
Continuous (3 x 380-440 V) [A]	1.2	2.2	3.7	5.3	7.2	9.0	12.0	15.5
Intermittent (3 x 380-440 V) [A]	1.8	3.3	5.6	8.0	10.8	13.7	18.0	23.5
Continuous (3 x 440-480 V) [A]	1.1	2.1	3.4	4.8	6.3	8.2	11.0	14.0
Intermittent (3 x 440-480 V) [A]	1.7	3.2	5.1	7.2	9.5	12.3	16.5	21.3

Max. cable size:

(mains, motor) [mm<sup>2</sup>/ AWG]

4/10

Max. input current

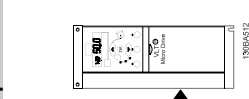

Continuous (3 x 380-440 V) [A]	1.9	3.5	5.9	8.5	11.5	14.4	19.2	24.8
Intermittent (3 x 380-440 V) [A]	2.6	4.7	8.7	12.6	16.8	20.2	27.4	36.3
Continuous (3 x 440-480 V) [A]	1.7	3.0	5.1	7.3	9.9	12.4	16.6	21.4
Intermittent (3 x 440-480 V) [A]	2.3	4.0	7.5	10.8	14.4	17.5	23.6	30.1

Max. pre-fuses [A]

Environment

Estimated power loss

at rated load [W]

Best case/Typical<sup>1)</sup>

Weight enclosure IP20 [kg]

Efficiency

Best case/Typical<sup>1)</sup>

1. Power loss at rated load conditions.

See Section *Fuses*

18.5/25.5	28.5/43.5	41.5/56.5	57.5/81.5	75.0/101.6	98.5/133.5	131.0/166.8	175.0/217.5
1.1	1.1	1.6	1.6	3.0	3.0	3.0	3.0
96.8/95.5	97.4/96.0	98.0/97.2	97.9/97.1	97.2/98.0	97.3/98.0	97.5/98.0	97.5/98.0

Table 8.1: Mains supply 3 x 380 - 480 VAC

## 8.2 Other Specifications

### Protection and Features:

- Electronic thermal motor protection against overload.
- Temperature monitoring of the heatsink ensures that the frequency converter trips in case of overtemperature
- The frequency converter is protected against short-circuits on motor terminals U, V, W.
- If a motor phase is missing, the frequency trips and issues an alarm.
- If a mains phase is missing, the frequency converter trips or issues a warning (depending on the load).
- Monitoring of the intermediate circuit voltage ensures that the frequency converter trips if the intermediate circuit voltage is too low or too high.
- The frequency converter is protected against earth faults on motor terminals U, V, W.

### Mains supply (L1/L, L2, L3/N):

Supply voltage	200-240 V ±10%
Supply voltage	380-480 V ±10%
Supply frequency	50/60 Hz
Max. imbalance temporary between mains phases	3.0 % of rated supply voltage
True Power Factor ( $\lambda$ )	≥ 0.4 nominal at rated load
Displacement Power Factor ( $\cos\phi$ ) near unity	(> 0.98)
Switching on input supply L1/L, L2, L3/N (power-ups)	maximum 2 times/min.
Environment according to EN60664-1	overvoltage category III/pollution degree 2

*The unit is suitable for use on a circuit capable of delivering not more than 100.000 RMS symmetrical Amperes, 240/480 V maximum.*

### Motor output (U, V, W):

Output voltage	0 - 100% of supply voltage
Output frequency	0-200 Hz (VVC+), 0-400 Hz (u/f)
Switching on output	Unlimited
Ramp times	0.05 - 3600 sec.

### Cable lengths and cross sections:

Max. motor cable length, screened/armoured (EMC correct installation)	15 m
Max. motor cable length, unscreened/unarmoured	50 m
Max. cross section to motor, mains, load sharing and brake *	
Maximum cross section to control terminals, rigid wire	1.5 mm <sup>2</sup> /16 AWG (2 x 0.75 mm <sup>2</sup> )
Maximum cross section to control terminals, flexible cable	1 mm <sup>2</sup> /18 AWG
Maximum cross section to control terminals, cable with enclosed core	0.5 mm <sup>2</sup> /20 AWG
Minimum cross section to control terminals	0.25 mm <sup>2</sup>

*\* See tables for mains supply for more information!*

### Digital inputs (Pulse/encoder inputs):

Programmable digital inputs (Pulse/encoder)	5 (1)
Terminal number	18, 19, 27, 29, 33,
Logic	PNP or NPN
Voltage level	0 - 24 V DC
Voltage level, logic '0' PNP	< 5 V DC
Voltage level, logic '1' PNP	> 10 V DC
Voltage level, logic '0' NPN	> 19 V DC
Voltage level, logic '1' NPN	< 14 V DC
Maximum voltage on input	28 V DC
Input resistance, R <sub>i</sub>	approx. 4 k
Max. pulse frequency at terminal 33	5000 Hz
Min. pulse frequency at terminal 33	20 Hz

## Analog inputs:

Number of analog inputs	2
Terminal number	53, 60
Voltage level	0 -10 V
Input resistance, $R_i$	approx. 10 k $\Omega$
Max. voltage	20 V
Current level	0/4 to 20 mA (scaleable)
Input resistance, $R_i$	approx. 200 $\Omega$
Max. current	30 mA

## Analog output:

Number of programmable analog outputs	1
Terminal number	42
Current range at analog output	0/4 - 20 mA
Max. resistor load to common at analog output	500 $\Omega$
Accuracy on analog output	Max. error: 0.8 % of full scale
Resolution on analog output	8 bit

*The analog output is galvanically isolated from the supply voltage (PELV) and other high-voltage terminals.*

## Control card, RS-485 serial communication:

Terminal number	68 (P,TX+, RX+), 69 (N,TX-, RX-)
Terminal number 61	Common for terminals 68 and 69

*The RS-485 serial communication circuit is functionally separated from other central circuits and galvanically isolated from the supply voltage (PELV).*

## Control card, 24 V DC output:

Terminal number	12
Max. load	200 mA

## Relay output:

Programmable relay output	1
Relay 01 Terminal number	01-03 (break), 01-02(make)
Max. terminal load (AC-1) <sup>1)</sup> on 01-02 (NO) (Resistive load)	250 V AC, 2 A
Max. terminal load (AC-15) <sup>1)</sup> on 01-02 (NO) (Inductive load @ cos $\phi$ 0.4)	250 V AC, 0.2 A
Max. terminal load (DC-1) <sup>1)</sup> on 01-02 (NO) (Resistive load)	30 V DC, 2 A
Max. terminal load (DC-13) <sup>1)</sup> on 01-02 (NO) (Inductive load)	24 V DC, 0.1A
Max. terminal load (AC-1) <sup>1)</sup> on 01-03 (NC) (Resistive load)	250 V AC, 2 A
Max. terminal load (AC-15) <sup>1)</sup> on 01-03 (NC) (Inductive load @ cos $\phi$ 0.4)	250 V AC, 0.2A
Max. terminal load (DC-1) <sup>1)</sup> on 01-03 (NC) (Resistive load)	30 V DC, 2 A
Min. terminal load on 01-03 (NC), 01-02 (NO)	24 V DC 10 mA, 24 V AC 20 mA
Environment according to EN 60664-1	overvoltage category III/pollution degree 2

*1) IEC 60947 part 4 and 5*

## Control card, 10 V DC output:

Terminal number	50
Output voltage	10.5 V $\pm$ 0.5 V
Max. load	25 mA

*The 10 V DC supply is galvanically isolated from the supply voltage (PELV) and other high-voltage terminals.*

## Surroundings:

Enclosure	IP 20
Enclosure kit available	IP 21
Enclosure kit available	TYPE 1
Vibration test	1.0 g
Max. relative humidity	5% - 95%(IEC 60721-3-3; Class 3K3 (non-condensing) during operation
Aggressive environment (IEC 60721-3-3), coated	class 3C3
Test method according to IEC 60068-2-43 H2S (10 days)	



Ambient temperature	Max. 40 °C
<i>Derating for high ambient temperature, see section on special conditions</i>	
Minimum ambient temperature during full-scale operation	0 °C
Minimum ambient temperature at reduced performance	- 10 °C
Temperature during storage/transport	-25 - +65/70 °C
Maximum altitude above sea level without derating	1000 m
Maximum altitude above sea level with derating	3000 m
<i>Derating for high altitude, see section on special conditions</i>	
EMC standards, Emission	EN 61800-3, EN 61000-6-3/4, EN 55011, IEC 61800-3 EN 61800-3, EN 61000-6-1/2, EN 61000-4-2, EN 61000-4-3,
EMC standards, Immunity	EN 61000-4-4, EN 61000-4-5, EN 61000-4-6
<i>See section on special conditions</i>	

## 8.3 Special Conditions

### 8.3.1 The Purpose of Derating

Derating must be taken into account when using the frequency converter at low air pressure (heights), at low speeds or at high ambient temperature. The required action is described in this section.

### 8.3.2 Derating for Ambient Temperature

The ambient temperature measured over 24 hours should be at least 5 °C lower than the max. ambient temperature.

If the frequency converter is operated at high ambient temperature, the continuous output current should be decreased.

The frequency converter has been designed for operation at max 50 °C ambient temperature with one motor size smaller than nominal. Continuous operation at full load at 50 °C ambient temperature will reduce the lifetime of the frequency converter.

### 8.3.3 Derating for Low Air Pressure

The cooling capability of air is decreased at low air pressure.

For altitudes above 2000 m, please contact Danfoss regarding PELV.





Below 1000 m altitude no de-rating is necessary but above 1000 m the ambient temperature or the maximum output current should be decreased. Decrease the output by 1% per 100 m altitude above 1000 m or reduce the max. ambient temperature by 1 degree per 200 m

### 8.3.4 Derating for Running at Low Speeds

When a motor is connected to a frequency converter, it is necessary to check that the cooling of the motor is adequate.

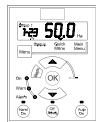
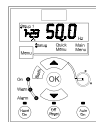
A problem may occur at low speeds in constant torque applications. Running continuously at low speeds – below half the nominal motor speed – may require additional air cooling. Alternatively, choose a larger motor (one size up).

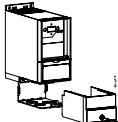
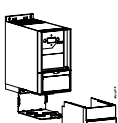
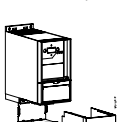
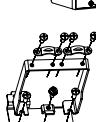
### 8.4 Options for VLT Micro Drive FC 51

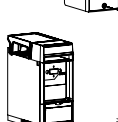
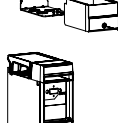
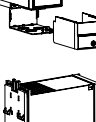
Ordering No	Description	
132B0100	VLT Control Panel LCP 11 w/o potentiometer	
132B0101	VLT Control Panel LCP 12 with potentiometer	
132B0102	Remote Mounting Kit for LCP incl. 3 m cable, IP55 with LCP 11, IP21 with LCP 12.	
132B0103	Nema Type 1 kit for M1 frame	
132B0104	Nema Type 1 kit for M2 frame	
132B0105	Nema Type 1 kit for M3 frame	
132B0106	De-coupling plate kit for M1 and M2 frames	
132B0107	De-coupling plate kit for M3 frame	
132B0108	IP21 for M1 frame	
132B0109	IP21 for M2 frame	
132B0110	IP21 for M3 frame	
132B0111	DIN rail mounting kit for M1 frame	

Danfoss Line Filters and brake resistors are available upon request.

## Index

### A

Active Set-up	17
Active Set-up	41, 46
Alarm, Warning And Extended Status Word	60
Ambient Temperature	65
Analog In/out	52
Analog Inputs	63
Analog Output	64
Automatic Motor Tuning (amt)	21

### B

Brake Resistor	48
Brake Resistor (ohm)	41
Brake Resistor Short-circuited	59
Brakes	48
Bus Termination	15

### C

Cable Lengths And Cross Sections	63
Clearance	9
Comm. And Options	54
Configuration Mode	22
Control Card, 10 V Dc Output	64
Control Card, 24 V Dc Output	64
Control Card, Rs-485 Serial Communication:	64
Control Terminals	15
Control Word According To Fc Profile	35
Controllers	53
Conversion Index	45

### D

Danfoss Fc Control Profile	35
Data Readouts	58
Dc-brake	42
Dc-brake	41
De-coupling Plate Kit	66
Derating For Ambient Temperature	65
Derating For Low Air Pressure	65
Derating For Running At Low Speeds	65
Digital In/out	51
Digital Inputs (pulse/enocder Inputs):	63
Digital Inputs:	63
Din Rail Mounting Kit	10, 66
Display	17
Disposal Instruction	8
Drive Information	57

### E

Earth Leakage Current	5, 7
Edit Set-up	17
Edit Set-up	41, 46
Electronic Waste	8
Emc-correct Installation	12
Explanation Of The Control Bits	35
Explanation Of The Status Bits	38

### F

Frequency Converter With Modbus Rtu	25
Function Codes Supported By Modbus Rtu	29
Fuses	11

**H**

Hand Mode	42
Hand Mode	47
How To Connect	11

**I**

Indicator Lights	18
Ip21	66
Isolated Mains Source	7
It Mains	7

**L**

Lcp 11	17
Lcp 12	17
Leakage Current	7
Limits/warnings	50
Load Compensation	41, 47
Load Sharing/brake	16
Load/motor	47

**M**

Main Menu	18, 24
Mains Connection	12
Mains Supply	61
Mains Supply (I1/I, L2, L3/n)	63
Mains Supply 1 X 200 - 240 Vac	61
Mains Supply 3 X 200 - 240 Vac	61
Mains Supply 3 X 380 - 480 Vac	62
Max. Reference	22
Maximum Reference	21
Mct-10 Set-up Software	17
Mechanical Dimensions	10
Mechanical Installation	9
Min. Reference	22
Minimum Reference	21
Modbus Rtu	25
Modbus Rtu Message Framing Structure	26
Modbus Rtu Overview	25
Motor Connection	13
Motor Current	20
Motor Direction	18
Motor Frequency	20
Motor Nominal Speed	21
Motor Output (u, V, W):	63
Motor Overload Protection	7
Motor Phase	42, 50
Motor Power	20
Motor Protection	63
Motor Speed High Limit	22
Motor Speed Low Limit	22
Motor Temperature	41
Motor Voltage	20

**N**

Navigation Keys	19
-----------------	----

**O**

Operation Keys	19
Operation/display	46
Options	66
Options For Vlt Micro Drive Fc 51	66
Other Specifications	63

Output Performance (u, V, W)	63
Overcurrent Protection	11
Over-voltage Control	41, 48

**P**

Parameter Number	18
Parameter Overview	41
Power Circuit - Overview	16
Preset Reference	22
Process CI Feedback Resource	23
Process Feed Forward Factor	23
Process Pi Anti Windup	23
Process Pi Integral Time	23
Process Pi Normal/inverse	23
Process Pi Proportional Gain	23
Process Pi Start Speed	23
Protection	11
Protection And Features	63

**Q**

Quick Menu	18, 19
Quick Menu Parameters	20

**R**

Ramp1 Ramp-down Time	22
Ramp1 Ramp-up Time	22
Readout Mode	18
Reference/ramps	49
Relay Output	64
Remote Mounting Kit	66
Residual Current Device	7

**S**

S200 Switches 1-4	15
Serial Communication	19
Set-up Number	17
Set-up Software	17
Side-by-side Installation	9
Slip Compensation	41, 47
Smart Logic	55
Special Conditions	65
Special Functions	56
Specifications	61
Status Menu	18, 19
Status Word According To Fc Profile (stw)	37
Surroundings	64
Switches	15

**T**

Template For Drilling	10
Terminal 60 Filter Time Constant	23
Terminal 60 High Current	23
Terminal 60 High Feedback Value	23
Terminal 60 Low Current	22
Terminal 60 Low Feedback Value	23
Thermistor	41
Thermistor Resource	47
Troubleshooting	59

**U**

UI Compliance	11
Unit	18

**V**

Value	18
Vlt Control Panel Lcp 11	66
Vlt Control Panel Lcp 12	66
Voltage Level	63

**W**

Warnings And Alarms	59
---------------------	----